

Teo Lehtimäki Oy



Italiano - English

Updated 31.11.2007

2008

2008

2008

2008

2008

Benvenuti sulle pagine Web dell' Azienda Teo Lehtimaki Oy

L'Azienda Teo Lehtimaki Oy è una azienda familiare, nata nel 1991.

Vendiamo pezzi di ricambio per le motoslitte. Esportiamo anche i nostri prodotti fuori Finlandia, principalmente negli altri paesi Nordici, nelle Alpi Europee, Estonia e Russia.

Noi importiamo pezzi di ricambio dai produttori di prima scelta come Camoplast, CV-Tech, IBC Canada, PPD Industries, è Garland.

La nostra azienda è flessibile e consegna velocemente. Abbiamo una vasta conoscenza di tutti ricambi dal settore della fabbricazione delle motoslitte sino alla messa sul mercato. Le nostre pagine danno anche aiuti tecnici, istruzioni di installazione e raccomandazioni su come usare i pezzi di ricambi. Vengono aggiornate regolarmente, per incoraggiare Voi a visitarle più spesso.



Catalogo 2008

Nel catalogo, fabbricazioni originali con il loro codice per identificarle correttamente . Il nostro prodotto di ricambio può essere diversa fabbricazione.

Teo Lehtimäki Oy

Vuopajantie 34 96400 Rovaniemi Finland

Teo Lehtimäki

info@teolehtimaki.fi

mob. +358-400-162110

mob. +358-400-426066

fax +358-16-366004

vat. FI08350750

Teo Lehtimäki

Artturi Lehtimäki

Teo Lehtimäki Oy

Kaarronnevantie 54 61800 Kauhajoki Finland

Vesa Peltonen

mob. +358-40-5769111

fax +358-6-2311170

Personal e-mails

teo@teolehtimaki.fi

vesa@teolehtimaki.fi

artturi@teolehtimaki.fi

Teo Lehtimäki

Vesa Peltonen

Artturi Lehtimäki

Financial questions

Eeva Lehtimäki

eeva@teolehtimaki.fi

www.teolehtimaki.fi

34 mm



NEW, NEW

Cobra

04-9052 38 x 307 cm

04-9061 38 x 345 cm

Vuotsolainen for Pilotski

New 31-04



31-04

Vuotsolainen for Pilot / RMK ski design model, width 195 mm, 8 mm

Polaris plastic ski 2007

31-04

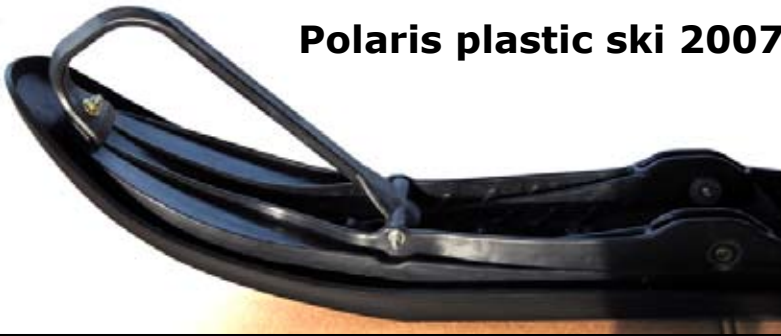

**MM148
MM202**

31-04

Yamaha, wide ski, 2007

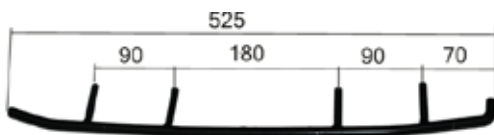

MM139



31-04

Yamaha, narrow ski 2007

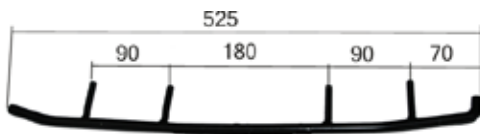

MM139



31-04

CTRL ski Lynx



**MM186
MM243**



Malli: MXZ 583

Vuosi: 1996 Skidoo

Moottori Rotax 583 96- Teho kW

09-772	mäntä, std
09-772-01	mäntä, 0,25 ylikoko
09-772-02	mäntä, 0,50 ylikoko
09-772-03	mäntä, 0,75 ylikoko
09-772-04	mäntä, 1,00 ylikoko
35-505	männäntapin laakeri
710-214	tiivistesarja, prof
09-167	kampiakselin tiiviste
09-165	kampiakselin tiiviste
09-16002	välitiiviste kampiakseli
35-6206NR	kampiakselin laakeri
35-6207NR	kampiakselin laakeri
35-6305	kampiakselin laakeri
01-158	käynnistimen jousi
01-154	käynn. korjaussarja



Owner: **Teo Lehtimäki**, sold

In the picture: **Tommi and Lotta**

38

307 / 22

**04-9793, 04-9009,
04-9830, 04-9753**

Telamatto, leveys cm, pituus cm , puikot kpl



30-21	L=140 cm musta
30-621	L=140 cm grafiitti
30-210	L=163 cm musta
30-321	L=140 cm keltainen

Note.

This page and 2000 more like this one:

**[www.teolehtimaki.fi/spare parts catalogue](http://www.teolehtimaki.fi/spare_parts_catalogue) and
pls, check your make.**

3700-3800 r/min, kytkentäkierrosluku
7900-8000 r/min, max. kierrosluku

Voimansiirto / Teo Lehtimäki Oy

P50- replace the original



15-19 (0019)
Cal: 7009
Spring: 0451-1118
Spring: 15-54
Shims: 5 + 1

Sähköosat

05-B8	Spark plug
01-14342	CDI-Boxes
01-15416	Rectifier
01-15415	Rectifier
01-14355	Ignition coil

Sukset

Steel ski

32-99	Ski skin
33-20	Ski skin CTRL model
MM142	Carbide runner

Muut osat / Teo Lehtimäki Oy

**We will update
these pages all
the time.**

04-6370

60 x 372 cm

B = 74 pcs

New

Nordik 600 SLE



6

Content

- 6- 10 Finn made tracks
- 11-17 **Camoplast** tracks
- 18-21 **Extensions, cleats**
- 22-23 **Slides**
- 24-26 **Sprockets, wheels**
- 26-27 **Springs**
- 28 **Bearings**
- 29 **Shafts, Syncro sproc. hooks**

- 30-33 **Ski skins**
- 34-38 **Runners**
- 39-45 **Pulleys, CVTech**
- 46-49 **Crank bearings**
- 50 **Carburetor flanges**
- 51-52 **Engine gaskets**
- 53-58 **Pistons**
- 59 **Fuel pumps**
- 60-61 **Brake pads, chains**
- 62 **Windshields**
- 63-66 **CDI, ign. coils**

Bombardier museum, Valcourt



Width 38 cm

A = 50 mm



Lynx, Winha, Skidoo, Nordik 300, R, 377R

04-3315	38 x 315 cm	B = 63 pcs
04-3333	38 x 330 cm	B = 66 pcs
04-3357	38 x 353 cm, Elan	B = 70 pcs
04-3392	38 x 392 cm	B = 78 pcs

Ockelbo

Lynx 320 and 330 models

04-3372	38 x 372 cm	B = 74 pcs
04-3375	38 x 375 cm	B = 75 pcs

If **A** = 70 mm, replace the sprockets



Sprockets for 27 mm
hexa driveshaft
37-04



Sprocket / idler
sprocket
37-03



Idler sprocket
20-5287

Width 50 cm

A = 50 mm



Lynx

Winha

04-5330

50 x 330 CM

B = 66 pcs

04-5370

50 x 372 CM

B = 74 pcs

04-5392

50 x 392 CM

B = 78 pcs

If **A** = 70 mm, replace the sprockets



Trapper, Nordik

04-5372

50 x 372 CM

B = 74 pcs

04-5382

50 x 382 CM

B = 76 pcs

Width 60 cm



04-6340	60 x 340 cm	B = 67 pcs Lynx Finlandia, Winha 60
04-6372	60 x 372 cm	B = 74pcs Lynx 635, Ockelbo 6000, Trapper 6000
04-6380	60 x 382 cm	B = 76 pcs Lynx 650 S slide suspension
04-6390	60 x 392 cm	B = 78 pcs Lynx 6000/650

Ockelbo 600



04-6000 HSB 54

Width 50 cm

04-9002
50 x 396 cm 32 MM

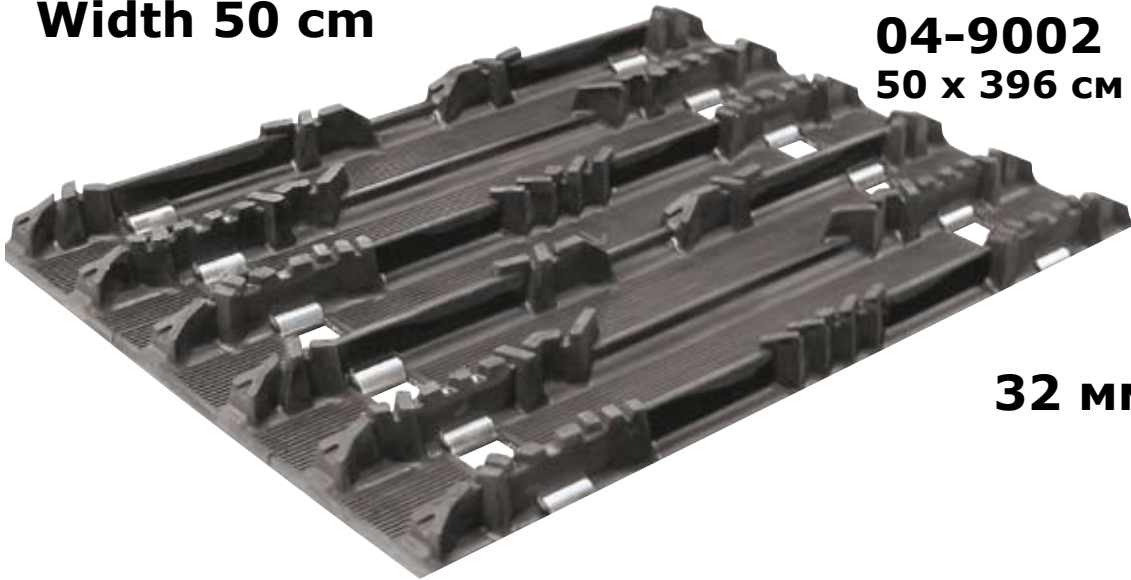

32 MM

10

**Bearcat, Scandik WT.
Lynx, Polaris.
Yamaha Viking**

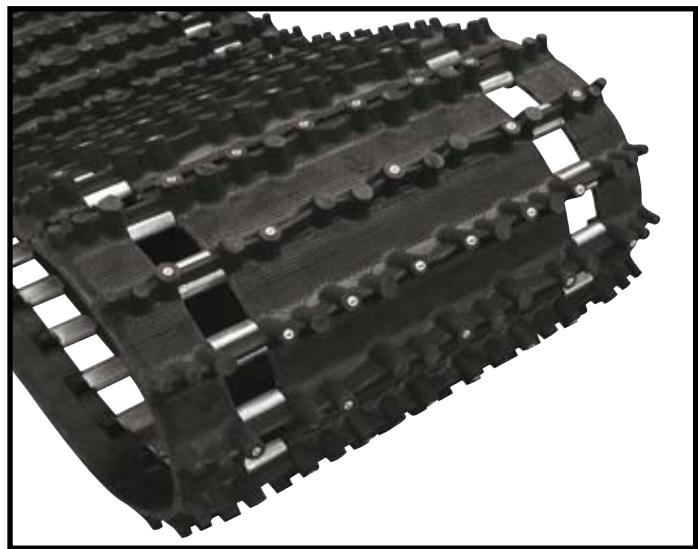

Ice Tech 04-9008
50 x 396 cm 32 MM

04-6330 60 x 330 cm B = 66 pcs

Aktiv Teddy



Challenger 25 mm

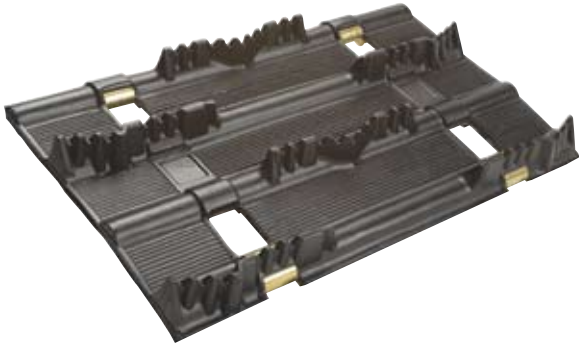

04-9793 38 x 307 cm 2/1
04-9794 38 x 345 cm 2/1

TRACtion Control System



04-9955H144
38 x 307 cm

11

Durasport 25 mm

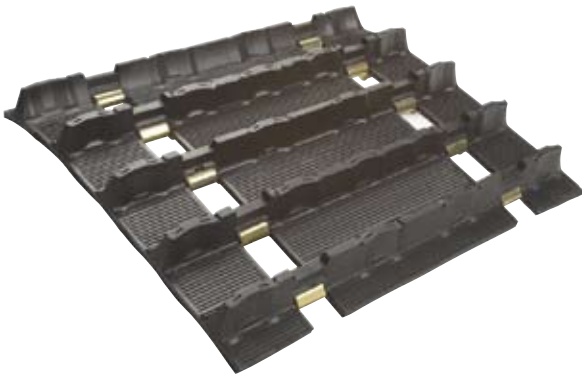

04-9753 38 x 307 cm fc
04-9863 38 x 345 cm fc

Hack Saw 25 mm



04-9009 38 x 307 cm fc
04-9010 38 x 345 cm fc

Ice Attak 27 mm



04-9028 38 x 307 cm fc
04-9029 38 x 345 cm fc

Challenger 25 mm

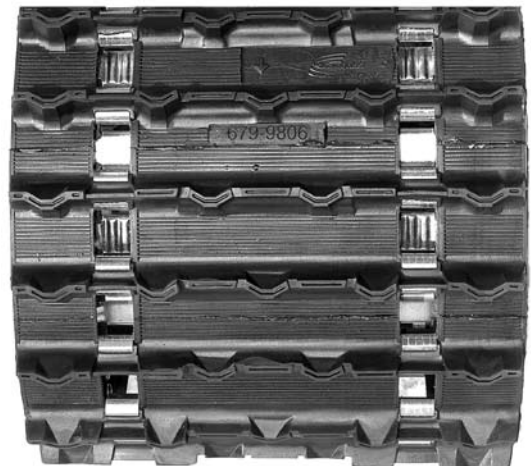

04-9806 38 x 396 cm fc

Special tracks

Yamaha

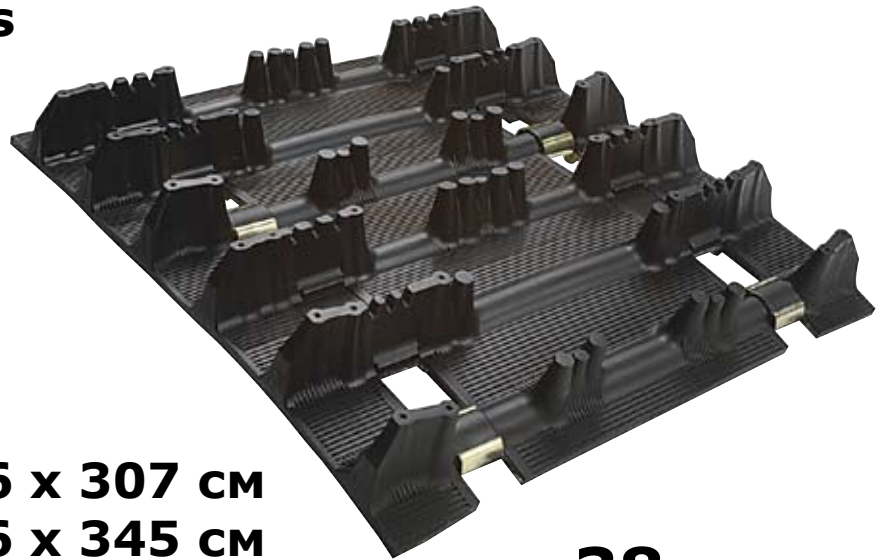

04-9033 36 x 307 cm
04-9034 36 x 345 cm
04-9044 36 x 365 cm

38 MM



Arctic Cat

25 MM

04-9960 34,3 x 325 cm

Skidoo



19 MM

Tundra, Alpine II, Scandik
04-9011 38 x 353 cm

Elan, Safari

04-9755 38 x 290 cm
Wheel suspension

04-9756 38 x 290 cm
slide suspension



32 MM

Rip Saw

04-9921 38 x 307 cm 3p
04-9040 38 x 325 cm 3p
04-9922 38 x 345 cm 2/1
04-9006 38 x 365 cm 3p
04-9007 38 x 384 cm 3p
04-9925 38 x 403 cm 3p

04-9001 34,3 x 325 cm

04-9021 41 x 346 cm fc

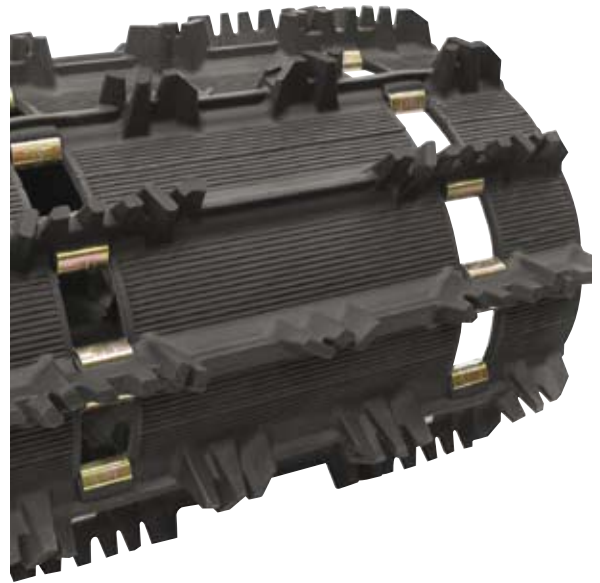

13

Ice Ripper, pitch 2,52"

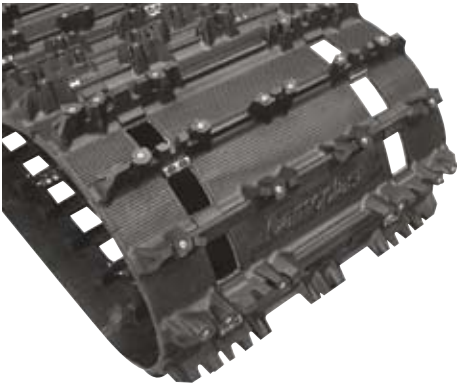

04-9993 38 x 307 cm
04-9000 38 x 345 cm

Ice Ripper , pitch 2,86"

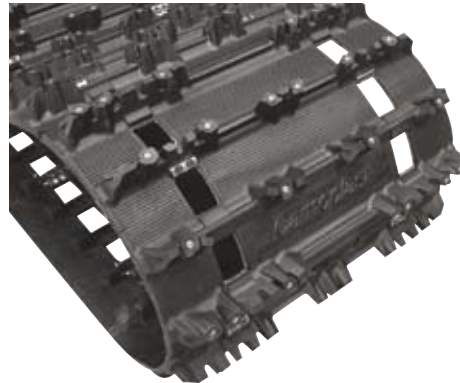

2,86"

04-9041 38 x 305 cm fc
04-9042 38 x 348 cm fc

Predator



04-9818 38 x 307 cm 2/1
04-9828 38 x 307 cm, мягкий
04-9819 38 x 345 cm 2/1

Full Block



04-9792 38 x 307 cm fc
04-9781 38 x 345 cm fc

Intense



38 MM

- 04-9803** 38 x 307 cm 3p
- 04-9800** 38 x 345 cm fc
- 04-9930** 38 x 307 cm fc



Sokosti

3p

- 04-9003** 38 x 365 cm
- 04-9004** 38 x 384 cm
- 04-9005** 38 x 403 cm

Rip Saw 38 mm



- 04-9998** 38 x 307 cm 3p
- 04-9045** 38 x 325 cm 3p
- 04-9013** 38 x 345 cm 3p

Chassie: REV-XP

Pitch 2,86" full clip

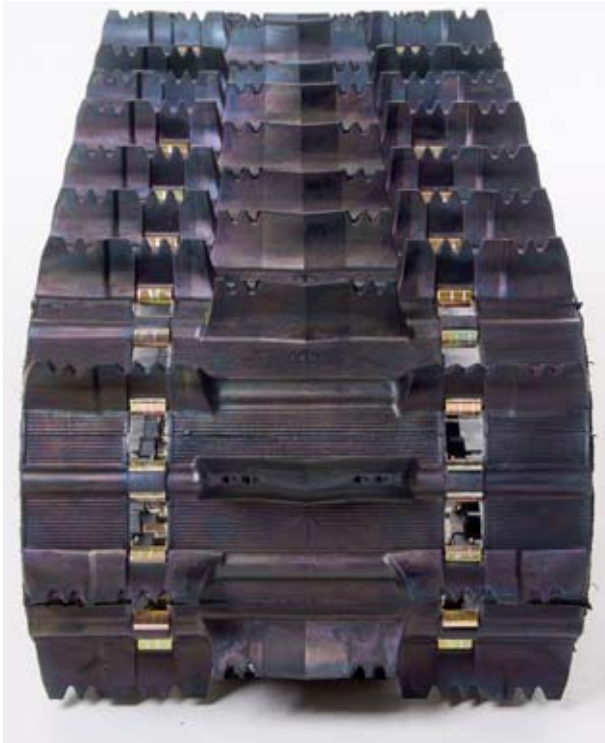

04-9069 40 x 305 cm x 44 mm (16" x 120" x 1,75")

04-9070 40 x 348 cm x 44 mm (16" x 137" x 1,75")

04-9075 38 x 305 cm x 38 mm (15" x 120" x 1,5") Rip Saw

04-9076 38 x 348 cm x 38 mm (15" x 137" x 1,5") Rip Saw

Hox. Hox. Hox. Hox.

All Rev-XP chassis are wide enough to use 41 cm, 16" wide tracks.

Chassie: REV

Pitch 2,52" full clip

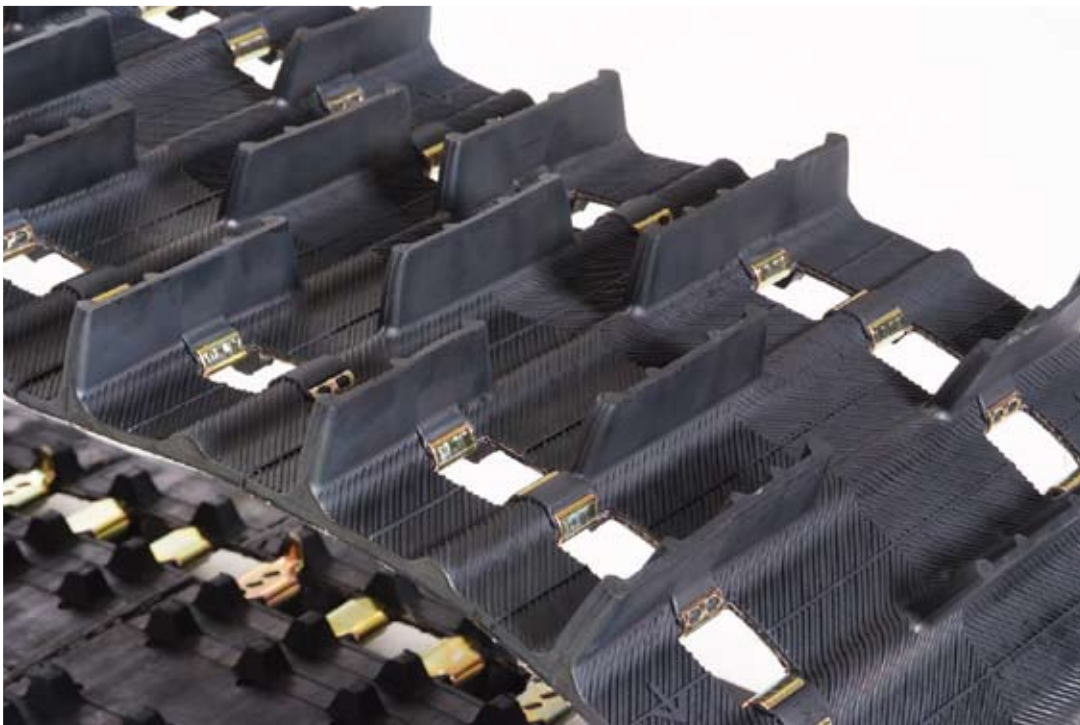

04-9071 38 x 307 cm 44 mm (15" x 121" x 1,75")

04-9072 38 x 325 cm 44 mm (15" x 128" x 1,75")

04-9073 38 x 345 cm 44 mm (15" x 136" x 1,75")

04-9074 38 x 365 cm 44 mm (15" x 144" x 1,75")

Maverick

Next generation Mountain Track designed to provide outstanding performance in deep bottomless powder, while maintaining transit capability on hard pack.

NEW



3"

Top portion of profile designed to bend, compacting snow versus "cutting" and trenching, providing optimal performance in powder.



Rigid columns, "fingers" strategically positioned at the ends of profiles provides optimum performance in hard packed snow.



57 MM

04-9025

38 x 388 cm 57 MM

pitch 3" full clip

04-9030

41 x 411 cm 57 MM

pitch 3" full clip

04-9031

38 x 411 cm 57 MM

pitch 3" full clip

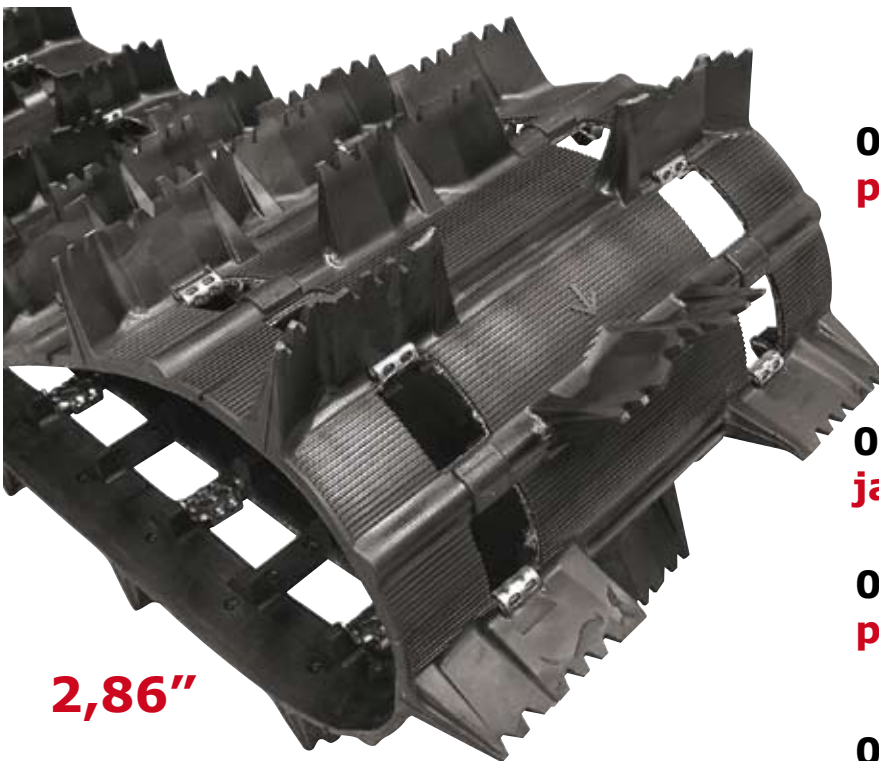

2,86"

63 MM

04-9942 38 x 365 cm

pitch 3" full clip

57 MM

04-9064 41 x 371 cm

jako 2,86" full clip

04-9065 41 x 391 cm

pitch 2,86" full clip

04-9066 41 x 414 cm

pitch 2,86" full clip

Check if available

Challenger

51 MM



04-9798	38 x 307 CM	fc
04-9797	38 x 345 CM	fc
04-9875	38 x 365 CM	fc
04-9876	38 x 384 CM	fc
04-9808	38 x 396 CM	fc

17

44 MM



04-9933	41 x 345 CM	fc
----------------	--------------------	-----------

51 MM

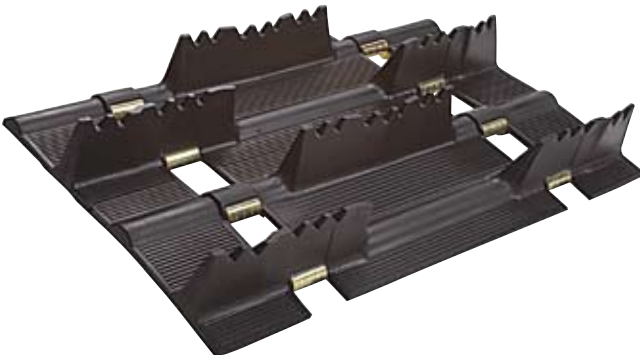

04-9899	41 x 365 CM	fc
04-9919	41 x 384 CM	fc
04-9920	41 x 403 CM	fc

57 MM

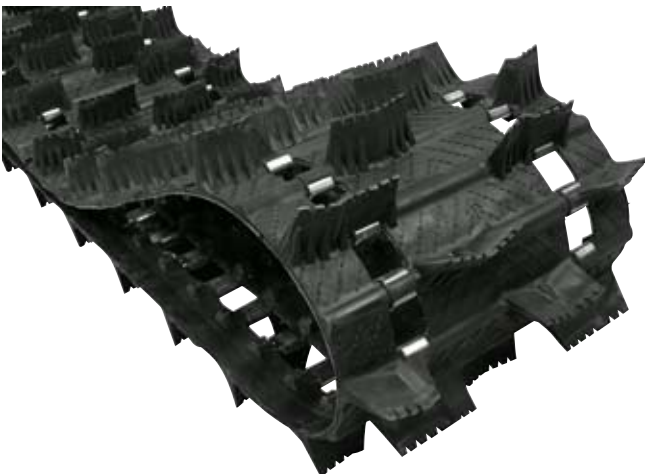

04-9978	38 x 403 CM	fc
----------------	--------------------	-----------

Extendings

04-3050
universal 12 cm



04-3060
Yamaha 12 cm



04-3080
Yamaha 20 cm



04-3300
Lynx 20 cm

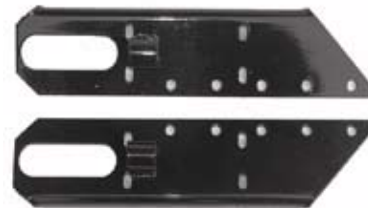

04-3040
universal 25 mm shaft
20 cm



Flip

Pictures:

In the pictures, you can see mounting of a 384 cm long track.

In order to achieve the best possible track alignment, mount the shaft as far to the left as possible



Aluminium profiles



04-3001

chassie 400-420 mm
length 600 mm

04-3003

chassie 415-430 mm
length 600 mm



By using this profile, the chassie can be extended by max. 400 mm. Note, that you cannot attach a tow hook on this profile without appropriate brackets.

04-3002

chassie 400-410 mm
length 200 mm

By using this profile, the chassie can be extended by max. 150 mm.

Cleat

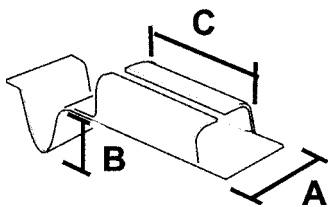

p/n	A	B	C
38-01	18	-	30
38-02	21	-	30
38-03	20	16	30
38-04	23	18	21
38-05	21	-	38
38-06	22	19	38
38-07	21	-	19
38-08	22	-	20
38-09	19	14	25
38-10	19	-	25
38-11	19	16	37



38-03

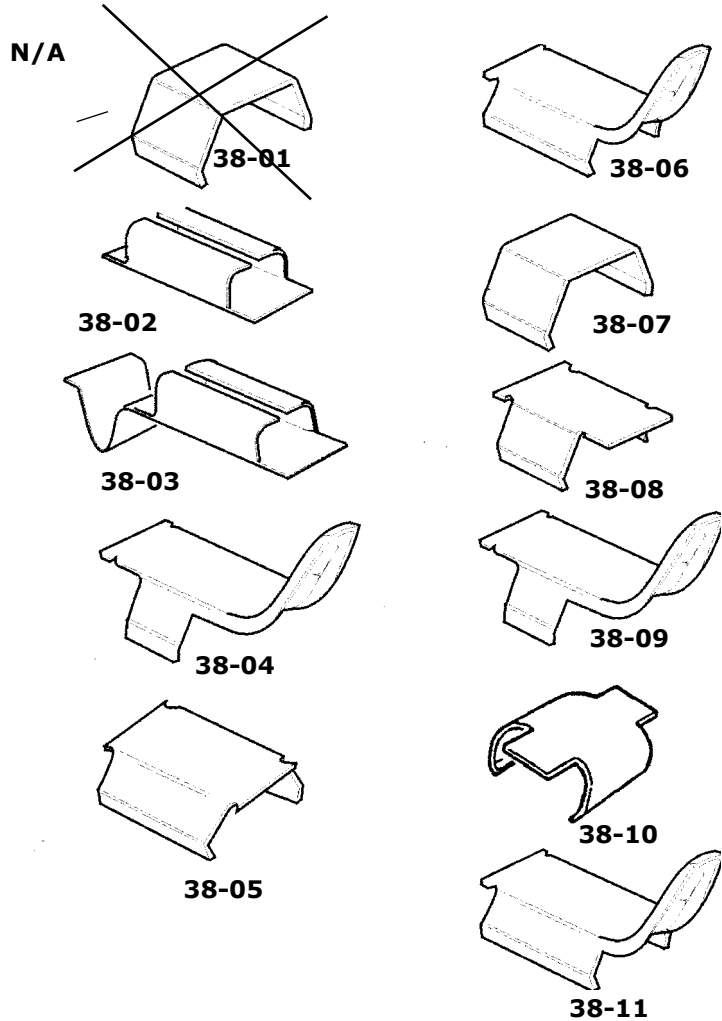

04-9925 + 04-3000 = 403 cm

This old 345 cm track can be replaced with 403 cm Predator as shown on the picture below. Boggie has been extended, 180 mm idler wheels at the rear. 04-3000 extension kit will be delivered with all needed parts except screws and rivets.



365 cm



384 cm



Lynx

04-9953 38 x 325 cm



Orig. track 320 cm
or 330 cm long

Adjustment is long
enough



Runner shoe

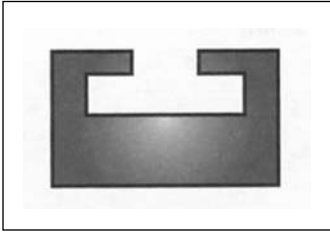

30-01 140cm black

30-601 140 cm graphite

30-010 **163 cm** /black

Fits: Lynx- all models
Ski-Doo, Trapper, Nordik-300,500,600

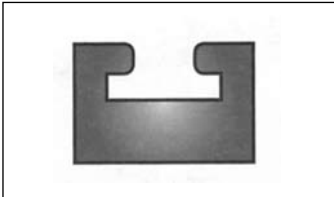

30-10 140 cm black

30-610 140 cm graphite

30-410 167 cm orange

Fits: Arctic Cat, all models after -78

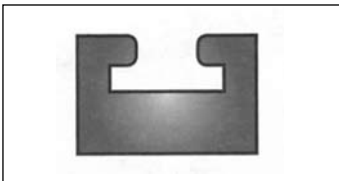

30-167 167 cm black

Fits: Arctic Cat, Super Jag

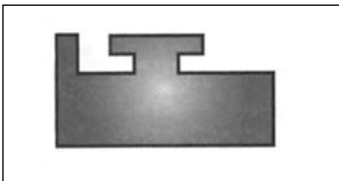

30-15 140 cm black

30-615 140 cm graphite

30-150 **145 cm** black

Fits: Polaris, all models

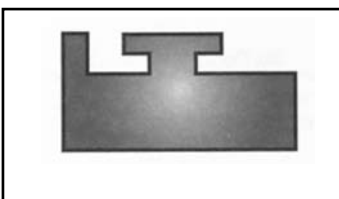

30-618 140 cm grafit

Fits: Polaris- Storm, XCR, wide profile



30-240 **163 cm** black/new

Fits: Polaris 2003 mountain

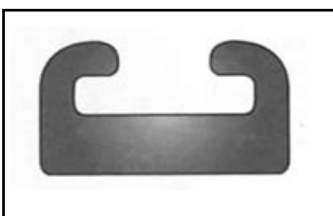

30-260 **167 cm** graphite/new

30-360 **167 cm** yellow/new

Skidoo. Renegade 2005, Mach 1...

Runner shoe

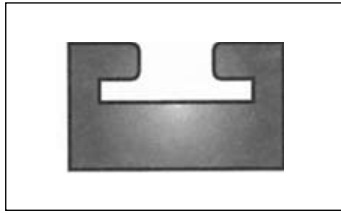

30-16 140 cm black

30-616 140 cm graphite

Fits: Yamaha Viking, Exciter 87-90, Phaser 90

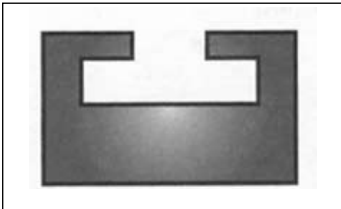

30-00 155cm white

the slot is bigger than the prod. 30-01 Ski-Doo

Fits: Nordik- 377 R, 540, 550

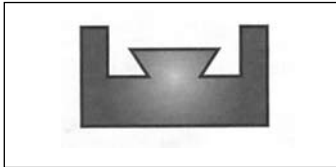

30-12 140 cm black

30-312 140 cm pink

30-612 140 cm graphite

Fits: Yamaha- Phaser, Ovation, SRV, SS

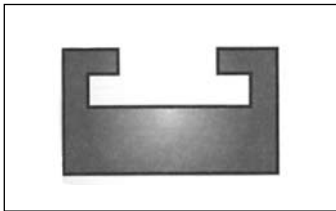

30-20 140 cm black

30-620 140 cm graphite

30-200 **145 cm** black

Fits: Yamaha, new profile

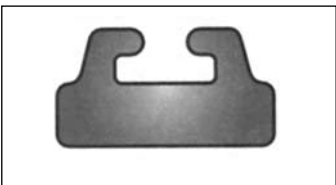

30-21 140 cm black

30-621 140 cm graphite

30-210 **163 cm** black

30-321 **140 cm yellow**

Fits: Ski-Doo, new profile

Lynx G-type

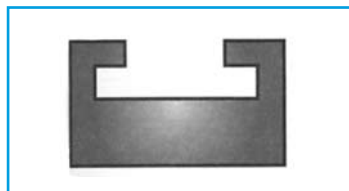

30-625 145 cm graphite

Yamaha 2006- some models

Yamaha 2007 Phaser

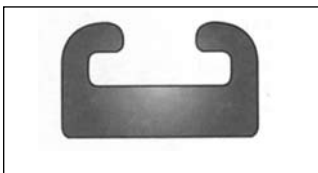

30-23 140 cm black

30-623 140 cm graphite

30-230 **167 cm** black/new

Fits: Polaris 2000- profile

Sprockets



20-5287



20-5289



37-03



37-04



21-07N



37-06



21-08AC

- 20-5285** pitch 2.00
sprocket, 9-teeth, width 25 mm
fits: Ockelbo
- 20-5286** pitch 2.00
sprocket, 9-teeth, width 30 mm
fits: Ockelbo, Nordik, Trapper, Lynx
- 20-5287** pitch 2.00
sprocket, 11-teeth
fits: Nordik 300, Lynx 539 4211
- 20-5288** pitch 2.00
sprocket, 10-teeth
fits: Nordik 540, 550, PSS
- 20-5289** pitch 2.52
internal Challenger 04-9806
fits: Lynx, Nordik
- 37-00** Sprocket 9-teeth/ 22 mm width
- 37-01** Sprocket 9-teeth/ 30 mm width
- 37-02** Sprocket 10-teeth/ 30 mm width
- 37-03** Sprocket 11-teeth 430 0103
- 37-04** Sprocket 11-teeth/ hexa shaft
- 37-06** for steel flanges
- 21-08AC** Sprocket 8-teeth 24 mm hexa
21-08LY Sprocket 8-teeth 31 mm hexa
- 21-09PO** Sprocket 9-teeth 24 mm hexa
21-09LY Sprocket 9-teeth 31 mm hexa
- 21-07K** Sprocket 7-teeth hexa shaft 24 mm
21-07G Sprocket 7-teeth hexa shaft 26 mm
- 21-07N** Sprocket 7-teeth, square shaft

Idler wheels

diameter = dia

20-117 4625 black 6202-5/8
fits: Polaris dia 117

20-108 4250 black 6202-5/8
fits: Ski-Doo 414 5759, Polaris dia 108

20-127 5000 black 6202-5/8 lynx
fits: Lynx 143 0701, Ockelbo dia 127

20-133 12993 black 6004
fits: Lynx 440 0410 dia 133



20-135 silver dia 135 6205
20-135F silver fullmoon 6205

20-5350 silver 6205 + 3/4
fits: Polaris dia 135

20-5630 black 6205
20-5630H silver 6205
20-5630G green 6205
fits: Arctic Cat dia 143



20-155 black dia 155 6205
fits: Ski-Doo, Nordik

20-180 silver dia 180 6205

20-190 black dia 190 6205



20-165K yellow dia 165

20-165S blue dia 165 6205

20-165P red dia 165 6205



20-6380H silver dia 160 6205

20-6375S blue dia 160 6205

20-6375P red dia 160 6205

20-130 black dia 130 6004 yamaha

20-131 black dia 180 6204 yamaha
Yamaha



Inserts

20-34 insert 3/4 " pair

20-58 insert 3/4 " pair

Non Slip drive sprocket

39-08 drive sprocket 8-tooth
 39-09 drive sprocket 9-tooth.
 39-10 drive sprocket 10-tooth

Pitch 2,52"



39-18 drive sprocket 8-tooth



Pitch 2,86"



20-178
Idler wheel
 178 mm
 Bearing 6204 2RS



20-152 152 mm
 Bearing 6205 2RS



20-162 162 mm
 Bearing 6205 2RS

39-27 drive sprocket 7-tooth
 39-28 drive sprocket 8-tooth



Pitch 3,00"

Spring, front / pair



41-3281 8,0mm mm. Lynx 250,3900

41-3000 9,0mm mm. Lynx 5900



41-8797 10mm mm. Ranger King
 538797, 538798

41-8796 9,0mm 538796, 538795



41-1530 9,0mm mm Lynx 5900,
 ring and hook

40-4715 8,5mm Nordik 500, 540, 550, 600



40-CA 8,0mm mm. Karibo, Arctic Cat

Rear springs / heavy duty / pair



40-AC 11,5 MM
Arctic Cat the last models



40-POLA 11,5 MM
8 turns
Polaris, Skidoo, Lynx



40-VI 12,0 MM
Yamaha Viking



40-PO 11,5 MM
9 turns
Polaris onward 1990

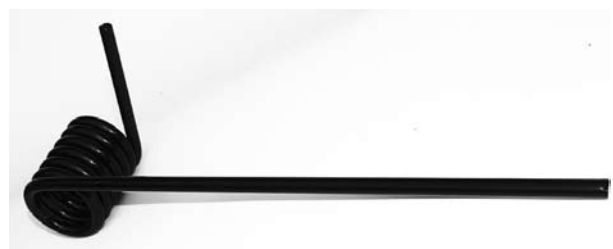

40-EDGE 11,0 MM
Polaris EDGE



40-POL 11,5 MM
Polaris up to 1989, with hook

Rear springs / normal / pair



41-8805 Lynx Ranger



41-4175 Lynx 3900 S



40-4721 Nordik 500-600



41-1531 Lynx



41-4277 Lynx 10,0 MM
Right hand springs shown in the pictures.



41-4500 Lynx 9,0 MM



40-4716

Bearings



- 35-6201**
- 35-6202**
- 35-620258**
- 35-6203**
- 35-6204N**
- 35-6303**
- 35-6304**
- 35-6205N**
- 35-CB205**
- 35-6004**
- 35-6005**
- 35-6006**
- 35-6008**



35-6205LU

35-SA205



35-6022
35-6228



35-UC205
35-UC205T



35-SB205
35-SB205T
35-3205

hole x outer dia x width

- 12x32x10 koyo
- 15x35x11 koyo
- 15,875x35x11 rom.
- 17x40x12 koyo
- 20x47x14 koyo
- 17x47x14 koyo
- 20x52x15 koyo
- 25x52x15 koyo
- 25x52x15 koyo, cone
- 20x42x12 koyo
- 25x47x12 koyo
- 30x55x13 koyo
- 40x68x15 koyo



25x52x15 NTN, Polaris chaincase

25,4x52x15 drive shaft

22x44x12 Yamaha driveshaft
28x58x16 koyo, Yamaha

25x52x17 koyo, Lynx drive shaft
25,4x52x17 koyo, Lynx counter shaft

25x52x15 koyo Lynx
25,4x52x15 koyo Lynx
Lynx gearbox
25x52x21

Start spring

- 01-1560** Rotax 414 783 400
- 01-158** Rotax 420 939 115
- 01-2080** Arctic Cat 3001-077
Polaris 308-3185
Yamaha 8YO-15713-00-00
- 01-2083** Arctic Cat 3002-921
Polaris 308-3495
- 01-206** Sachs
- 01-207** Kohler



Pawl kit Rotax



01-154



01-153

Rear shaft



11-02	3450701	Lynx 250, 360
11-03	3501775	Lynx GLX, 5900, 650
11-04	3501911	Lynx GLX, 5900, 650
11-08	5492814	rear shaft Lynx 250
11-09	5493615	rear shaft Lynx 5900
11-10	5496216	rear shaft Lynx 360, 3900
11-11	05032390	rear shaft Nordik 500, 540
11-12	05032389	rear shaft Nordik 300, 377R

Counter shaft

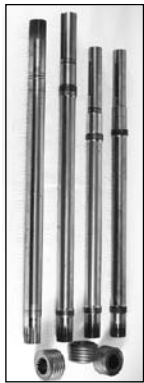

11-20	5394111	Lynx 250S, 3900S
11-21	5398073	Lynx 360S, Ranger
11-22	539990	Fox -99
11-23	5146138	Fox 00-
11-25	875138073	Syncro connection insert

Syncro sprockets



43-65	from 1992
lower sprocket, wide	z=64 8751-55048
sprocket, left	z=33 8751-47643
sprocket, right	z=33 8751-47644
43-64	up to 1992
lower sprocket, wide	z=64 8751-55048
sprocket, left	z=31 8751-47202
sprocket, right	z=31 8751-47203

Hook



12-01



12-02



12-03 Polaris



12-04 Skidoo

Extra wide skis

design model

31-01	Width	250 mm	8 mm universal model
31-02	Width	200 mm	8 mm universal model
31-03	Width	230 mm	8 mm universal model
31-00	Alpine II		8 mm
31-04	Width	195 mm	8 mm universal model



31-01 Vuotsolainen **31-02** Vuotsolainen

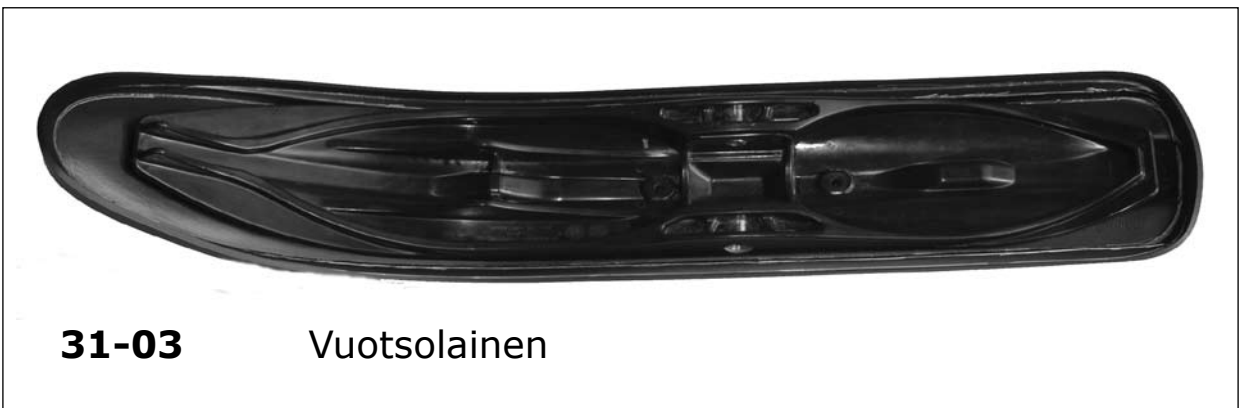

31-03 Vuotsolainen

Fits very well also to other ski models, such as Yamaha, Arctic Cat, Polaris, ADJ etc.

31-04 Vuotsolainen for Pilot / RMK ski, design model

width 195 mm, 8 mm

You can use 1, 2, or 3 carbide runners



31-03 L Vuotsolainen for Pilot ski 230 mm 8 mm
 31-03 R Vuotsolainen for Pilot ski 230 mm 8 mm



31-04 Vuotsolainen Pilot

31-04



33-50 Narrow Pilot

33-50



Plastics for plastic skis



33-10 Arctic Cat



33-30 Katamaran ski



33-40 Polaris



33-60- Skidoo / Lynx flex



**33-20 Lynx CTRL
not pre-drilled, multipurpose**



33-50 Pilot, narrow model



33-70 Skidoo1996-



33-80 Yamaha SRX 1998-



33-90 Yamaha 2000 / Skidoo / Lynx



33-99 Yamaha RX-1

**31-06 Bottom pan
6 x 800 x 1000 mm**

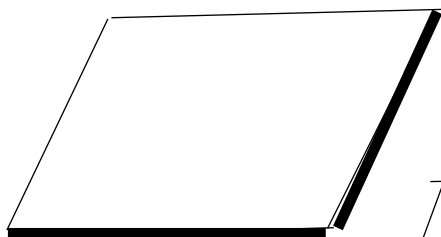

31-00-20 Alpine II



Plastic

31-07

8 x 150 x 3000

31-08

8 x 150 x 2000

Plastic ski skins

8 mm HPDE.

 32-01 Arctic Cat	 32-06 Arctic Cat
 32-00 Ockelbo	 32-11 Trapper, Nordik
 32-99 Safari, Scandic 380	 32-21B Formula, Snowexpert



This ski needs normal runner **MM277** and Carbide **MM147**
Ski skin 33-90 fits nice this blow moulded Skidoo ski

 32-61 Lynx	 32-41 Polaris 1993-
 32-51 Polaris -92, Ockelbo	 32-81 Yamaha Viking
 32-88 Yamaha Phaser 98-	 32-91 Yamaha V-max 94-

Ski runners

AKTIV

Alaska	1986
Panther	1984-86
Karibo	1984-

ARCTIC CAT

El Tigre	1980-84
Jag	1980-91
Pantera	1980-85
Panther	1980-89
Super Jag	1987-92
Trail Cat	1980-81

Cheetah Tour	1987-91
Coucar	1987-91
El Tigre	1987-90
Jag AFS	1989-91
Manx	1991
Pantera	1987-90
Panther	1990-91
Wild Cat 650	1988-90

Ext Special	1992
Ext 580,Z	1993-94
Jag Special,Z	1992
Prowler Spec.	1992-94
Wild Cat 700 EFI	1992-94
ZR 440	1993-95
ZR 580,700	1993-95
Thunder Cat	1996

Bear Cat 340,440	1995-99
Cheetah Tour	1992-94
Cougar	1992-97
Ext, EFI	1992-93
Jag AFS DL	1992-93
Manx	1992-93
Pantera	1992-97
Panther	1992-93
Prowler	1991-96
Prowler 2-UP	1992-94
Puma	1991-97
Thunder Cat	1993-95
Wild Cat EFI	1992

El Tigre	1985-86
Cougar	1985-86
Cheetah	1986
Pantera	1986

Plastic Skis	1996-
--------------	-------

normal

carbide

MM203

MM169

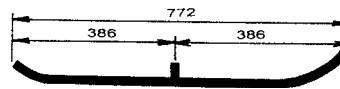

MM203

MM169

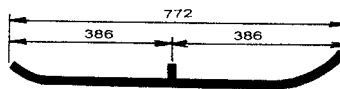

MM205

MM170



MM260

MM133



MM210

MM173

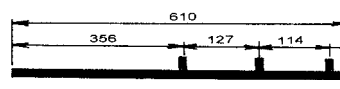

MM261

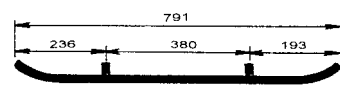

MM262

MM157

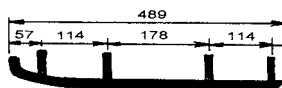

Ski runners

normal

carbide

		normal	carbide
LYNX		MM242	MM189
Forest Fox	1999-		GLX 5900, LTS 1991-93 GL Sport, LTS 1991-92 Ranger 1993
GL360, 250	1991-93		
GL 2300	1990		
GL 3300	1989-90		
GL 3900, LTS	1991-92		
GLS 3900	1989-90		
<hr/>			
GL 250, 2505	1986-89	MM230	MM187
GL 3900	1983-88		
GL 5900	1983-90		
535, 650	1983-87		
640	1988		
<hr/>			
GLS 3300	1986-89	MM240	MM188
GLS 3500 F/C	1990-93		
GLS 3600 L/C,	1990-91		
3800 Rave			
Cobra	1992-93		
Cobra Touring, Rave	1993		
Cobra Racing, Enduro	1993		
Ultra			
<hr/>			
230, 250, 650	1989-93	MM241	
<hr/>			
G-type Rave	1997-99	MM265	MM154
Enduro 600			
<hr/>			
G-type Racing	1998-	MM250	MM193
Sport XR 98			
<hr/>			
G-type	1997-99	MM279	MM146
Enduro 500			
<hr/>			
Ranger short	2000-	MM277	MM147
metall ski			
<hr/>			
FLEX plastic ski	2000-	MM243	MM186
plastic ski Skidoo	2003-		
<hr/>			
ADJ ski	2003-		

Ski runners

SKI DOO

Citation 1980-91
Elan 1971

Safari Cheyenne 1989-91
Alpine II 1991-95

Blizzard 1978-84
Everest 1974-83
Nordik 1981-83
Olympique 1976-79
Skandic 277, 377 1982-85
TNT 1973-78

Formula Mach I 1989-94
Formula MX, XTC 1985-95
Formula Plus, XTC 1985-93
Formula SS 1995-96
Formula ST, STX 1994-96
Grand Touring 470 1995
Safari DL, 503 Rally 1993-94
Safari GLX, LCE, L 1990-94
Skandic II 377, 503 1992-94

Formula SP DL 1985-86
Safari 377, 447, 503 1984-88
Safari, Saga, Scout 1989-92
Skandic 377, 503 1986-87
Tundra 1985-97

Formula III 1985-96
Formula Mach Z 1985-96
Formula MXZ 1993-95
Formula Z 1994-96
G-Touring 583, 670 1993-96
Summit 1994-96

Formula 500, DL 1996-99
Formula 583 1996-99
Formula S, SL, SLS 1995-99
G-Touring 500 1996
Scandic 380, 500 1995-

MXZ 440, 583, 670 1996-99

Formula 583 1998
Formula III 600, 700 1997-99
Formula Mach I, Z 1997-99
Formula Z 1997-99
G-Touring 583, 670 1997-99
Summit 1997-99

Plastic ski FLEX 1997-

Blow moulded 2003-
Plastic ski
Skandic 380-550 2003-

normal

carbide

MM211

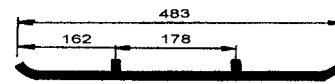

MM174

MM215

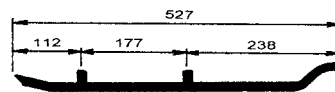

MM176

MM275

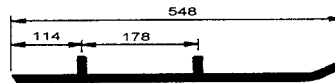

MM145

MM216

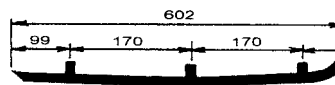

MM163

MM229

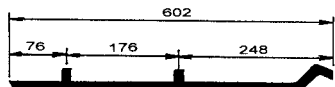

MM143

MM250

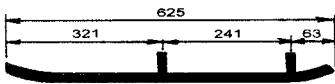

MM193

MM142

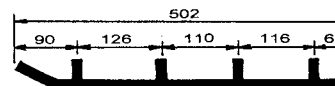

MM279

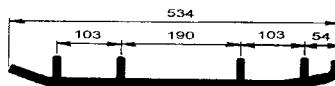



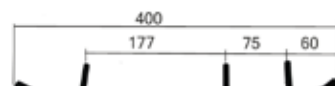

MM146

MM227

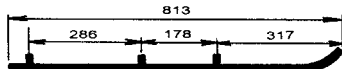
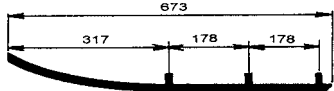
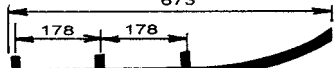

MM147

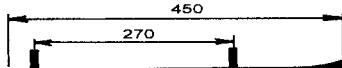
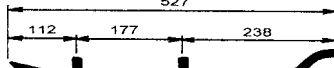
Ski runners

		normal		carbide
POLARIS				
All mod.	1971-82	MM208		
Indy 400	1984-85			
Indy 600	1983-85			
Indy Trail	1983-85			
Longtrac	1983-85			
Indy Sport	1983			
SS	1983-85			
Star, LT	1983-85			
<hr/>				
Indy 400	1986-87	MM 209		MM177
Indy 600	1986-87			
Indy Trail	1986-87			
Indy Longtrack	1986-87			
Indy Sprint	1986-87			
SS	1986			
Star, Startrack	1986-87			
<hr/>				
Indy Sport	1987	MM206		MM159
All mod.	1988-98			
All with metal skis	1998-99			
<hr/>				
Пластиковые лыжи				
Indy RMK 700	1997-	MM270		MM149
Indy XC 440	1997-			
Indy XCR 600	1997-			
Indy Storm	1997-			
Indy Ultra	1997-			
<hr/>				
OCKELBO				
All mod.	-1986	MM207		MM160
<hr/>				
All mod.	1987-	MM228		MM162
<hr/>				
NORDIK				
Nordik 300-377		MM215		MM176
Nordik 500-600				
Nordik 540-600 SL				
<hr/>				
SLP ski		MM290		MM190
<hr/>				
Pilot ski, Skidoo		MM274		MM144

Ski runners

YAMAHA

BR 250	1982-94
ET 250, 300, 340	1977-84
SR 540	1980-84
SRX 440	1976-80

ET 340	1985-88
--------	---------

Exiter 570	1987-90
SR 540, V-MAX 540	1987-91

BR 250 T, TS	1984-98
ET 340 T,TR	1981-88
ET 400 T, TR	1989-91
EX 340, 440	1977-81

CS 340	1990-99
Exiter II 570, SX	1991-93
Phazer II, E, ST	1984-99
SR 540	1985-86
V-Max 540	1983-86
Viking II 540	1988-92
XLV 540	1985-91

ET 410 TR	1992-99
Viking II 540 E	1993-99
Venture 480	1991-99

V-Max-4	1992-94
Venture 500,600,700	1995-96
V-Max 500, 600, 700	1994-96
V-Max 800	1995-97

V-max 500, 600, 700	1997-99
Venture 500,600,700	1997-99

SRX 600, 700	1998-
--------------	-------

RX, RX-1	2002-
----------	-------

normal

carbide

MM219

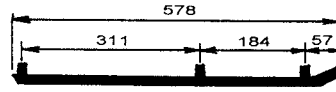

MM217

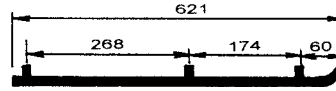

MM138

MM224

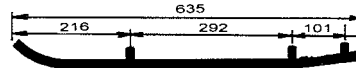

MM164

MM280

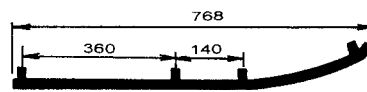

MM137

MM232

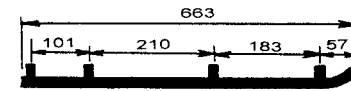

MM166

MM235

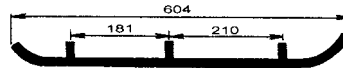

MM175

MM251

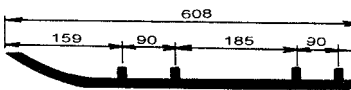

MM194

MM281

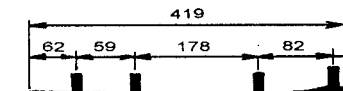

MM136

MM282

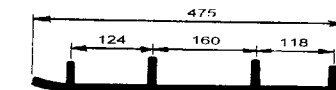

MM135

MM239

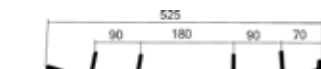

MM139



Huoltovapaa kytkin nyt suuriin nestekoneisiin. Tässä kytkimessä ei ole kuluvia holkkeja, vipuja tai muita osia, jotka voisivat käytössä kulua. Erittäin toimintavarma.

Kytkimeen voidaan asentaa alkuperäinen starttikehä. Kytkin toimittetaan valmiiksi kalibroituna, ja starttikehän tilalla on teräsrengas, joka tarvittaessa korvataan alkuperäisellä starttikehällä.

Kytkin sai Moottorikelkkalehden testeissä hyvän arvosanan.

Available in January 2008

You can find all calibrations on our web page at:

[www.teolehtimaki.fi/spare parts catalogue](http://www.teolehtimaki.fi/spare_parts_catalogue)

P50 clutch

The part number is blue

All calibrations are on the pages:

[www.teolehtimaki.fi/spare parts catalogue](http://www.teolehtimaki.fi/spare_parts_catalogue)

Our home page is updated frequently to assure most up-to-date information on our products.



Number	S4B	P50 number	CVTech	PTO	Belt	x	Use
15-01	6513B	0403-0001		3,65	31,2		15-02
15-02	5913B	0403-0002		2,50	31,7		15-02
15-03		0403-0003	15-0147C	8,77	34,8	8	15-03
15-04		0403-0004	15-0148C	8,77	34,8	8	15-04
15-05	0513B	0403-0005		11,5	33,3	6	15-05
15-06	8113B	0403-0006	15-0149C	6	34,9		15-06
15-07	5413B	0403-0007		7,5	34,9		15-06
15-09	9513B	0403-0009		11,5	34,9	6	15-09
15-10	9713B	0403-0010		5	33,3		15-10
15-11	9213B	0403-0011	15-0151C	1,5	34,9		15-11
15-18	9113B	0403-0018	flange	4,99	34,9		15-18
15-19	9613B	0403-0019		8,58	34,9	6	15-19
15-20		0403-0020		8,77	34,8	8	15-03
15-21	9313B	0403-0021	flange	0,06	34,9		15-21
15-22	3113B	0403-0022	flange	0,06	32,7		15-22

X = screw for ring gear, 6 mm or 8 mm



19-100



19-120



18-170
18-171
18-140
17-112
18-160

screw
Polaris screw
shim
nut
shim



19-050



16-08



16-07



17-040 Cap



19-030



P50 springs

Number	CVTech	N min / 72 mm	N max / 45 mm	Length mm	A dia. mm	Note
15-52	0151-0002	618 / 637	1050 / 1115	110 / 108	5,26 / 5,50	+ 1
15-51	0151-0003	730 / 730	987 / 1056	158 / 132	4,88 / 5,50	+ 1
15-55	0151-0004	728 / 708	1110 / 1056	134 / 127	5,26 / 5,50	
15-53	0151-0006	500 / 499	1070 / 1142	095 / 93	5,71 / 6,00	
15-54	0451-1118	500 / 501	700 / 832	148 / 114	4,50 / 5,50	+ 1
15-55	0451-1129	700 / 708	1100 / 1056	123 / 127	5,26 / 5,50	
15-56	0451-1137	595 / 604	852 / 929	135 / 122	4,88 / 5,50	+ 1

When the engine is running with full RPM capacity, the spring rate is somewhat higher on the **Blue Spring** than the spring rate of the CVTech spring. The calibration can be adjusted by adding one shim into each block. Remember that one shim corresponds 100 RPM. If the engagement RPM differs from the number of rotations given for the motor, always check the spring adjustment of the driven pulley and the alignment. The performance of the engine is only as good as the calibration of the powerline.

ALT springs

Number	CVTech	length mm	min. kg	max. kg
19-12	X-5243212	70	11	171
19-02	X-5243300	76	43	182
19-01	X-5243302	79	53	192
19-03	X-5243304	83	69	209
19-04	X-5243306	86	85	211
19-05	X-5243308	89	94	213
19-06	X-5243310	92	104	216
19-07	X-5218212	70	7	114
19-08	X-5218214	73	19	121
16-20	X-5218300	76	30	127
19-09	X-5218302	79	39	132
19-11	X-5218312	95	77	152
19-13	X-5218304		39	120

Driven pulley, spare parts



14-06



14-10

ALT-clutch



15-1213A



15-0513A



15-2913A



15-3113A



15-1713A

Arctic Cat		p/n	spring	shims	weight
All models	1970-80	1213	ask	ask	
Jag 4000	1981	1213	3	10	
Pantera 5000	1977-81	1213	3	12	
Panther 4000	1977-81	1213	3	9	
El Tigre 5000	1978-80	1213	3	12	
Trail Cat 4000	1980-81	1213	3	10	
Ski-Doo					
Alpine640	1969-75	0913	3		150
Alpine640	1975-82	0613	3		150
Citation 4500/SS	1980-83	0513	1	9	
Citation LS/E	1985-91	3913	1	12	
Elan 250/247cc	1971-96	1013	1	12	
Elan 248-294 cc	1973-79	1013	1	4	
Elite 464 cc	1975-79	0513	1	12	
Everest TNT	1975-79	0513	1	4	
Everest 444/464	1978-83	0513	1	12	
Everest 500	1980-83	0513	1	9	
Olympic mod	1969-75	1013	ask	ask	ask
Skandic 277	1983	3913	2	6	
Scandic 377 / R	1982-87	0513	1	9	
Tundra LT / LTS	1985-92	3913	1	12	
Skidoo models	1965-80	kysy	ask	kysy	ask
Polaris					
Polaris models	1970-80	2815	ask	ask	ask
Star, L/T	1983-87	2815	1	4	
Yamaha					
BR 250	1982-84	2913	1	13	
BR 250 TS, T, LT	1984-01	3113	1	12	
ET 250	1977-81	1713	1	4	
ET 300	1979-84	2913	1	4	
ET 340E, T, TR	1978-88	2913	1	6	
ET 400T, TR	1989-91	2913	1	11	
EC 340 338 cc	1981-88	2913	1	6	
EC 540 535 cc	1979-82	2913	1	12	
EX 340 338 cc	1976-78	2913	1	6	
EX 440 433 cc	1976-81	2913	1	13	
Phazer 433 cc	1984-89	3113	1	13	
SRV 540	1984-91	3113	1	12	
SRX 440	1976-80	3113	1	13	
SS 440	1980-85	3113	4	13	
STX 340	1976-77	2913	1	6	
STX 440	1976-77	2913	1	13	
XLV 540	1985-90	3113	1	12	
Motoski					
Motoski	1973-80	kysy	ask	ask	ask
Futura 400, E	1977-79	0513	3	8	
Futura 444, LC	1978-79	0513	3	7	
Futura 464, RV	1980-83	0513	3	10	
Futura 500	1980-83	0513	3	10	
Mirage 1.	1980-83	0513	2	10	

ALT-clutch



15-3913A



16-11



16-06



16-09



16-08



16-07



16-02



16-16



17-200

Lynx		p/n	spring	shims	weight
L 320 295 cc	197?-80	1213A	1	9	
L 520 295 cc	197?-83	1213A	1		60
L 330 340 cc	197?-80	1213A	1	8	
L 535 440 cc	197?-79	1213A	1		60
L 635 440 cc	197?-79	1213A	1		90
GLX 503 cc	1981-82	1213A	1		60
GLX / 5900	1984-93	0513A	1		60
L 535 503 cc	1981-83	1213A	1		60
L 535 503 cc	1984-87	0513A	1		60
L 635 / XL	1981-83	1213A	1		90
GL 3300 377 cc	1982	0513A	2	12	
GL 3900 377 cc	1982-91	0513A	2	12	
L 650 503 cc	1982-92	0513A	1		90
L 250, S 253 cc	1985-91	0513A	2	6	
GL 3300 S 503 c	1984-89	0513A	1	7	
GL 3300 377 cc	1989-90	0513A	1	12	
Ockelbo					
Oc 300	1978-80	3113A	2	14	
Oc 600-1	1978-80	3113A	2	14	
Oc 600-2	1979-81	0513A	2		60
Oc 8000	1980-88	0513A	2		90
Oc 6000	1980-88	0513A	2		60
Oc Poro	1983-85	0513A	2	6	
Oc 4000	1982-83	0513A	2	7	
Oc 5000	1983-88	0513A	2		60
Oc 3500	1986-88	0513A	2	6	
Oc 4500	1986-88	0513A	2		60
Fighter	1988	0513A	2	10	
Trapper		Nordik			
Trapper 5000	1984-	0513A	1	10	
Trapper 6000	1984-	0513A	1		90
Nordik 300, R	1988-	3913A	1	10	
Aktiv					
Aktiv models	1976-82	1213A	ask	ask	ask
Aktiv models	1983-	0513A	ask	ask	ask
Terri 30					
Terri	1975-	0513A	5		

spring

- 1= 19-01
- 2= 19-02
- 3= 19-03
- 4= 19-04
- 5= 19-05

Clutch

- 0513A= 15-0513A
- 0613A= 15-0613A
- 0913A= 15-0913A
- 1013A= 15-1013A
- 1713A= 15-1713A
- 2913A= 15-2913A
- 3113A= 15-3113A
- 3913A= 15-3913A
- 5013A= 15-5013A **new**



spring 1-5

S4B -clutch



15-0513B
15-3113B
15-6513B
15-9513B
15-9713B



18-130



18-030



18-100



17-050



17-051



18-060
18-090



18-120



17-090



16-07



16-08



18-086
18-102
18-108
18-114
18-121

spring 086 mm
spring 102 mm
spring 108 mm
spring 114 mm
spring 121 mm



18-170
18-171
18-140
17-112
18-160

screw
Polaris screw
shim
nut
shim

18-200
18-201

puller M14x1,5 L-30
puller M14x1,5 L-120

Ski-Doo		S4B	CVtech	spring
SS 25	1984	0513B	15-05	ask
Safari 377	1984-88	0513B	15-05	ask
Safari L, LE	1990-92	0513B	15-05	ask
Scout, Saga	1989-92	0513B	15-05	ask
Tundra 2, LT	1993-97	9713B		ask
Polaris				
Lite GT,Deluxe	1991-98	6513B	15-02	ask
Sport GT	1991-92	6513B	15-02	ask
Starlite, GT	1991-93	6513B	15-02	ask
Sport touring	1993-96	6513B	15-02	ask
Yamaha				
SR540	1981-87	3113B		ask
Viking 540	1988-92	3113B		ask
Exciter 570	1987-90	3113B		ask
Viking 2 540 cc	1992-93	3113B		ask
Lynx				
GLS 3300	1987-89	0513B	15-05	ask
GLS 3500	1990-91	0513B	15-05	ask
GLS 3600	1990-91	0513B	15-05	ask
GLS 3800	1990-91	0513B	15-05	ask
L 5900 503 cc	1983-93	0513B	15-05	ask
L Forest Fox	1993-99	9513B		ask

Driven pulley

14-00 KW-8-25-270 MVLТ

-dia 25 mm shaft

-dia 270 mm

Ockelbo. Lynx, Trapper Max 1049 belt

14-01 KW-22,2-250 NK

-dia 22,2 mm shaft, 5mm keyway

-dia 250 mm

Terri 30

14-03 5100-0172

-dia 22,2 mm shaft, 6 mm keyway

-dia 250 mm

Lynx



Adjusting

Whenever you install a new clutch or repair the old one, always remember to check driven pulley, tension and condition of the spring. Very often the spring is "dead" and does not do its job.

If the spring in driven pulley is "dead", it allows the clutch to shift too early and the engine has no possibility to run well. Replace or tighten the spring, also you can clean parts but do not use grease.

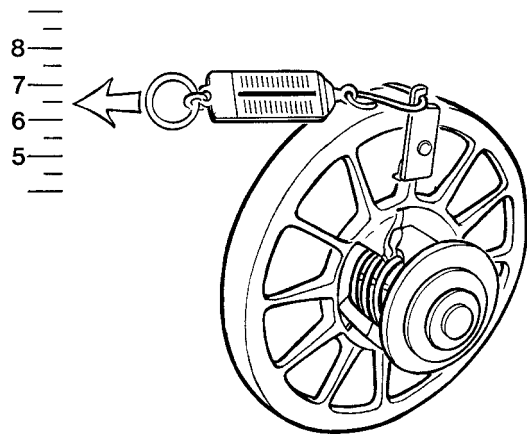

Powerline

Check the powerline with 12 mm thick iron bar. If there is no rubber stopper to stop the engine turning when using the throttle, then **Y** must be 1,0 - 1,5 mm bigger than **X**. Note also that due to a smaller clutch, the distance **Z** in your service manual does not exist. It is something else, but the difference is acceptable.

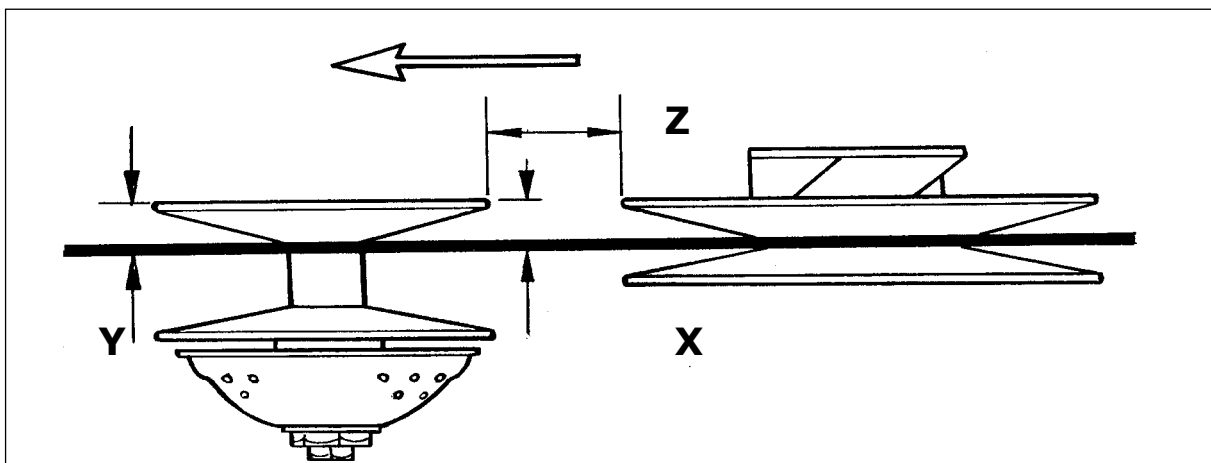

Arctic Cat crankshaft bearings

2-CYL F/C	MGT	CENTER	PTO
340 F/C inj.	DG2555	DG2555	83519 x 83519
440 F/C 1980-97	83519	83519 x 83519-D	83519 x 83519
440 F/C 1988-00	83519	83519 x 83519-D	83519 x 83519
500 F/C	83519 x 83519	83519 x 83519-D	83519 x 83519
570 F/C	6306YR13LT2	6306YR13LT2 x 6306YR13NSL71	OEM
2-CYL L/C			
440 L/C	83519 x 83519	83519 x 83519-D	35NQ5523
440 L/C 1987-89	83519 x 83519	83A073A x 83A073B	83A072-9 x 2
440 L/C ZR-1995	83A073-9	83A073A x 83A073B	40NQ 6430
440 L/C ZR 1996-00	83A073-9	83A073A x 83A073B	40NQ 6430
500-600 ZR T-CRANK	83A073-9	83A073A x 83A073B	40NQ 6430
F-5 04	OEM	83B551A 30mm x 2	40NQ 6430 SP
530 L/C	83519 x 83519	83A073A x 83A073B	83A072-9 x 2
550 L/C 1991-92	83A073-9	83A073A x 83A073B	40NQ 6430
550 L/C 1993-99	83A073-9	83A073A x 83A073B	40NQ 6430
580 L/C 1993-99	83A073-9	83A073A x 83A073B	40NQ 6430
600 ZR 2000-01	306/1DYR1W10MGT	83B551A 30mm x 2	40NQ 6430
650 L/C CARB.	83B551A 35mm	83B551A 35mm x 2	40NQ 6430
700 L/C EFI 1993	83B551A 35mm	83B551A 35mm x 2	40NQ 6430
700 L/C 1994-97	83B551A 35mm	83B551A 35mm x 2	40NQ 6430
F6-F7 2003-05	OEM	83B551A 35mm x 2	40NQ 6430 SP
800-900 ZR 00-03	306/1DYR1W10	6307R/1DYR1NSLT x 2	3208/1DW11
3-CYL L/C			
600 L/C ZRT 600 L/C ZRT 00-01	83A073 A	6207R9-83A073B 6207R9-83A073A	40NQ 6430
900 L/C 1993-00 1000 L/C 1998-00	6306 / 4DYRILT	6209 / DYRILT x 3 6209 / 1DYR1NSLT	6209/1DYRILT x 2
800-900-1000 93-			
2000 BAL SHAFT	6205 C4	6205 C4 x 2	6205 C4

Part number Dimensions

35-35BG06S9	35 X 62 X 23,8
35-5206 S9	30 X 62 X 23,8
35-6007 C4	35 X 62 X 14
35-6007 PC4	35 X 62 X 14
35-6205 C4	25 X 52 X 15
35-6205 NRC4	25 X 52 X 15
35-6206 C4	30 X 62 X 16
35-6206 PC4	30 X 62 X 16
35-6206 NRC4	30 X 62 X 16
35-6206 GPC4	30 X 62 X 16
35-6206 GSPC4	30 X 62 X 18/19

35-6207 C4	35 X 72 X 17
35-6207 PC4	35 X 72 X 17
35-6207 R9	35 X 72 X 17
35-6207 NRC4	35 X 72 X 17
35-6207 GPC4	35 X 72 X 17
35-6207 GSPC4	35 X 72 X 17/18
35-6207 9BA-9T2C4	35 X 72 X 24
35-6208 PC4	40 X 80 X 18
35-6208 GSPC4	40 X 80 X 21
35-6209 1DYRILT	45 X 90 X 19
35-6209 1DRINSLT	45 X 90 X 18

Polaris crankshaft bearings

1-CYL F/C	MGT	CENTER	PTO
250 F/C 1985-95	6206 C4		6206 C4 x 2
2-CYL F/C			
340 F/C INJECTION	6206 C4	6007 C4 x 2	6206-GPC4 x 6206-C4
440-500 F/C	6206 PC4	6206 PC4 x 2	6206-GPC4 x 6206-PC4
440 XEF-550 F/C 98-00	5206 S9	6206 PC4 x 2	6206-GPC4 x 6206-PC4
2-CYL L/C			
440 L/C SPEC 95-96 moon key	6206 PC4	6206 PC4 x 2	6206-GPC4 x 6206-PC4
440 L/C SPEC. 97 USA	6207 C4	OEM x 2	6207-NRC4 x 6207-C4
440-500-600 L/C 98-02 USA	6207 C4	OEM x 2	6207/9BA9T x 6207-C4
440-500 L/C SEAL PTO 30	6206 PC4	6206 PC4 x 2	6206-GPC4 x 6206-PC4
500 L/C 96-00SEAL PTO 32	6206 PC4	6206 PC4 x 2	62/63-GPC4 x 62/63-PC4
500 L/C 00-02 MGT moon key	5206-371BLT	6206 PC4 x 2	62/63-GPC4 x 62/63-PC4
700 L/C 1997-98	6207 C4 x 2	6207 C4 x 2	6207-NRC4 x 6207-C4
700 L/C 1999-04	6207 C4 x 2	6207 NRC4 x 2	6207/9BA9T x 6207-C4
800 L/C USA 2000-04	6207 C4 x 2	6207 NRC4 x 2	6207/9BA9T x 6207-C4
3- CYL L/C			
580 L/C 92-94 mono block	6206 PC4	6206 PC4 x 4	6206 GPC4 x 6206-PC4
600 L/C 95-99 mono block	5206-S9	6206 PC4 x 4	6206 GPC4 x 6206-PC4
600 L/C 97 oil jet PTO m.b	5206-S9	6206 PC4 x 4	6206 GPC4 x 5206-S9
600 SP-680 L/C 96-98	35BG06-S9	6007-PC4 x 4	6207 GPC4 x 6207-PC4
650 L/C CARB-RXL 85-98	5206-S9	6206-PC4 x 2	6206 GPC4 x 5206-S9
750-800 L/C STORM 93-97	6207-PC4 x 2	6207-PC4 x 4	6307 GP x 6307-PC4
700-800 XCR 99-03	35BG06-S9	6007-PC4 x 4	6207 GPC4 x 6207-PC4

47

Yamaha crankshaft bearings

1-CYL F/C	MGT	CENTER	PTO
250 ET	6206 C4		6306 NRC4
250 BRAVO	6305 H/INDY		6306 NRC4
2-CYL F/C			
300 F/C-340 cc ET	83464-C	83548D-9	
400 cc-410 cc F/C	83464-C	83548D-9 x 83548D-9	
485 cc-500 cc F/C	DG3268-B	DG3268-B x DG3268-B	
535 cc-540 cc F/C	83548D-9	83548D-9 x 83548D-9	
L/C WITH ROLLER	BEARING		
500-570-600cc 87-96	83B207		
500-600 1997-	83B207		

Part number Dimensions

35-62/32 GC4	32 X 62 X 17
35-6303 C3	17 X 43 X 14
35-6305 C4	25 X 62 X 17
35-6305 NRC4	25 X 62 X 17
35-6305 H/IDNY-9	25 X 68 X 17

35-6306 C4	30 X 72 X 19
35-6306 NRC435-	30 X 72 X 19
35-6307R-1DYR1NSLT C4	35 X 83 X 21
35-307/DYR1W10 C4	35 X 83 X 21
35-3208/1DW11 C4	40 X 83 X 30

Rotax = Lynx, Skidoo crankshaft bearings

1-CYL F/C	MGT	CENTER	PTO
247 F/C 1985-96 ELAN	6305 C4		6305 C4
253 F/C 1985-	6206 NRC4		6206 NRC4
277 F/C 1993-	6206 C4		6206 C4
377-447 1980-81 Points	6207-NRC4	6305-NRC4 x 6305-NRC4	6206-NRC4 x 2
2-CYL F/C			
377-447 1982-89 Nippo	6207-NRC4	6305-NRC4 x 6206-NRC4	6206-NRC4 x 2
377-447 1990-96	6207-NRC4	6207-NRC4 x 2	6207-NRC4 x 2
377-447 1997-	6207-NRC4	6207-NRC4 x 2	6207-PC4 x 2
503 1979-81 Points	6207-NRC4	6305-NRC4 x 6305-NRC4	6206-NRC4 x 2
503 1982-89 Nippo	6207-NRC4	6305-NRC4 x 6206-NRC4	6207-NRC4 x 2
503 1990-96	6207-NRC4	6207-NRC4 x 2	6207-NRC4 x 2
503 1997-	6207-NRC4	6207-NRC4 x 2	6207-NRC4 x 2
550 F/C 2003-	6207-NRC4	6207-PC4 x 6207-PC4	6207-GSPC4 x 6207-PC4
640 F/C 1970-82	6306-NRC4	6306-NRC4 x 6306-NRC4	6306-NRC4
2-CYL L/C			
444 L7C 1977-79	6206-NRC4	6305-NRC4 x 2	6206-NRC4 x 2
454 L/C 1995-98	6206-NRC4 x 2	6206-PC4 x 2	6207-PC4 x 2
462 L/C 1984-86 SP-SS	6206-NRC4	6305-NRC4 x 6206-NRC4	6206-NRC4 x 2
464 L/C 1980-83 Nippo	6206-NRC4 x 2	6305-NRC4 x 6206-NRC4	6206-NRC4 x 2
467 L/C 1985-99	6206-NRC4 x 2	6305-NRC4 x 6206-NRC4	6207-NRC4 x 2
494 L/C 96-02 Tcrank	6206-NRC4 x 2	6206-PC4 x 2	6207-PC4 x 2
494 L/C 2003	6206-PC4 x 6206-GSPC4	6206-PC4 x 2	6207-GSP4 x 6207-PC4
532-536-537-582 85-99	6206-NRC4 x 2	6305-NRC4 x 6206-NRC4	6207-NRC4 x 2
600 L/C 1999-02	6206-PC4 x 2	6206-PC4 x 2	6207-PC4 x 2
600 L/C 2003	6207-PC4 x 6207-GSPC4	6206-PC4 x 2	6207-GSP4 x 6207-PC4
600-700 HO-SDI 2004	6207-PC4 x 6207-GSPC4	6207-PC4 x 2	6207-GSP4 x 6207-PC4
643-617 1991-93	6206-NRC4 x 2	6305-NRC4 x 6206-NRC4	6207-NRC4 x 2
670 L/C 1993-94	6206-PC4 x 2	6206-PC4 x 2	6207-NRC4 x 2
670 L/C 95-99 + HO	6207-PC4 x 2	6206-PC4 x 2	6207-PC4 x 2
700 L/C 1999-00	6207-PC4 x 2	6207-PC4 x 2	6208-PC4 X 2
700-800 L/C 2001-02	6207-PC4 x 6207-GSPC4	6207-PC4 x 2	6208-PC4 X 2
800 L/C 2003	6207-PC4 x 6207-GSPC4	6207-PC4 x 2	6208-GSP4 x 6208-PC4
800 L/ HO 2004-05 SDi	6207-PC4 x 6207-GSPC4	6207-PC4 x 2	6208-GSP4 x 6208-PC4
3-CYL L/C			
599 L/C 1995	6208-PC4	6206-PC4 x 4	6208-PC4 x 2
599 L/C 1996-1997	6208-PC4	6206-PC4 x 4	6208-PC4 x 2
599-699 L/C CK3 98-00	6208-PC4	6206-PC4 x 4	6208-PC4 x 2
700 L/C 1997	6208-PC4	6206-PC4 x 4	6208-PC4 x 2
779 L/C 1993-96	6208-PC4	6207-NRC4 x 4	6208-PC4 x 2
800 L/C 1997-01	6208-PC4	6207-PC4 x 4	6208-PC4 x 2

Part number Dimensions

35-6307 PC4	35 X 80 X 21
35-6307 GPC4	35 X 80 X 21
35-83464-C	25 X 62 X 17
35-83519	30 X 65 X 16
35-83519-D	30 X 65 X 16
35-83548D-9	32 X 62 X 16
35-83A072-9	35 X 75 X 17
35-83A073-9	30 X 72 X 19
35-83A073-A	30 X 72 X 16
35-83A073-B	30 X 72 X 16

35-83A209-1	30 X 72 X 19
35-83A726-9	35 X 80 X 21
35-83A779	32 X 78 X 19
35-83B551-A 35MM	35 X 75 X 17
35-83B551-A 30MM	30 X 75 X 17
35-DG2555 C3	25 X 55 X 15
35-DG3268-B	32 X 68 X 16
35-DG3278 JSO	32 X 78 X 16,5
35-40NQ6430W11	40 X 64 X 30

Needle cage

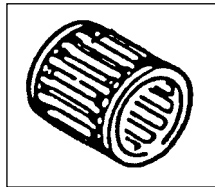

35-500	19 x 23 x 24 (1414)	35-513	16 x 20 x 20
35-501	16 x 20 x 22 (1404)	35-514	15 x 19 x 20
35-502	16 x 21 x 20 (1407)	35-515	16 x 22 x 17
35-503	18 x 23 x 22 (1413)	35-517	20 x 24 x 30
35-505	18 x 22 x 22 (1410)	35-520	18 x 23 x 21
35-506	16 x 20 x 24 (1406)	35-521	20 x 25 x 24
35-508	20 x 24 x 19 (1415)	35-522	16 x 20 x 22,5
		35-523	20 x 26 x 24
35-510	18 x 22 x 28 (1411)		
35-512	20 x 24 x 24 (1412)		

Oil seals

Arctic Cat

09-14600	30x62x10
09-14603	30x65x9/11
09-14605	35x75x9/11
09-14613	25x55x9
09-14616	35x75x8/10
09-14617	35x55x7

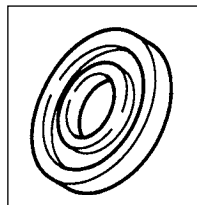

Ski-doo

09-113	30x42x7
09-11301	32x42x7
09-116	25x62x10
09-118	25x41,55x10
09-122	35x62x10
09-125	25x52x7/7,5
09-16002	25x62x63,5x5x6
09-16003	30x62x63,5x5x6
09-165	35x72x7/8
09-167	30x62x7/8
09-168	28x38x7
09-169	30x47x7
09-170	40x80x7

Sachs

09-108	30x47x8
09-114	25x35x7,9

Polaris

09-140	30x62x8
09-14102	30x44x7
09-14103	30x62x8/11
09-14104	30x44x5,7
09-14202	30x62/63,7x7
09-14619	40x64x8

Kohler

09-104	25x42x10/11
09-113	30x42x7

Yamaha

09-131	25x48x8
09-132	30x72x8
09-135	32x78x10x13
09-137	32x78x9,5
09-143	32x48x10
09-14301	35x80x6
09-14302	25/32x78x8
09-14303	25/32x48x8
09-14306	23/35x58x12
09-14311	32x48x9,2
09-14313	32x48x10

Carburetor flanges

Arctic Cat	
07-10001	CARB. FL. CAT. JAG 87-91, 0109-926
07-10013	CARB. FL .CAT+ POL+ YAM+ SKID. VM 30, 32, 34 HD,
07-10056	CARB. FL. CAT 3005-264 TM38 EFI
07-10059	CARB. FL. CAT 3005-147 3 VM36
07-10061	CARB. FL. CAT 3005-142 2 TM38
07-10501	CARB. FL. CAT VM 36, 38, HD, KOHLER, YAMAHA
Rotax	
07-10010	CARB. FL. ROTAX VM 34 STRAIGHT, SUORA
07-10011	CARB. FL. ROTAX VM 34 ANGLE, KULMA 570.1262.00
07-10012	CARB. FL. ROTAX VM ANGLE, 570.1261.00
07-10013	CARB. FL .CAT+ POL+ YAM+ SKID. VM 30, 32, 34 HD,
07-10020	CARB. FL. TUNDRA VM 34
07-10021	CARB. FL. MX 85-92, 570.1275.00
07-10022	CARB. FL. SKIDOO VM 34, 79-84, 570.1339.00
07-10023	CARB. FL. SKIDOO VM 40, 44, 570.038.200
07-10032	CARB. FL. ROTAX 2 VM40 420.867.805
07-10033	CARB. FL. ROTAX 2 VM 38 420.865.860
07-10034	CARB. FL. ROTAX 3 TM 38 TPS 420.867.848
07-10037	CARB. FL ROTAX 2 x VM38 570.025.400
07-10044	CARB. FL. ROTAX 3 TM 38DPM 420.867.776
Polaris	
07-10005	CARB. FL. POL. VM 38 SS, 3083171
07-10006	CARB. FL. POL. VM 32, 34, HR, 3083306
07-10008	CARB. FL. POL. VM 26, 3082255
07-10013	CARB. FL .CAT+ POL+ YAM+ SKID. VM 30, 32, 34 HD
07-10045	CARB. FL POL. 2 VM 34SS 3084325
07-10048	CARB. FL. POL 3TM48 EFI 3084043
07-10049	CARB. FL. POL 3VM38 3085248
07-10050	CARB. FL. POL 3VM38 3084652
07-10051	CARB. FL. POL. 2 TM40 TPS 1253327
07-10052	CARB. FL. POL 2 X KAIHIN 39 MM, 1253146
07-10054	CARB. FL. POL 3TM38 1253259
07-10058	CARB. FL. POL 2 VM 34SS 3085670
Yamaha	
07-10013	CARB. FL .CAT+ POL+ YAM+ SKID. VM 30, 32, 34 HD,
07-10504	CARB. FL YAMAHA B38-32 8VO-1355-00



Engine gaskets, professional, without oil seals

Number	Arctic Cat year gasket 840-old p/n	Piston
710-060A	FS CAT 440 FC, 80- , 09-696, 840-80607	09-696
710-063	FS CAT 500 CC, FC, 78-85, 09-693	09-693
710-063B	FC CAT 340 FC, 77- , 09-692, 840-80588	09-692
710-063C	FS CAT 500 EL T. 6000, 80-85, 09-694	09-694
710-063D	FS CAT 530 LC, 86-91, 09-699, 840-80632	09-699
710-063E	FS CAT 500 FC, 86-90, 09-691, 840-8061	09-691
710-179	FS CAT 440 LC 90-00, 09-695, 840-8181	09-695
710-180	FS CAT 700 LC, 91-96, 09-682, 840-8180	09-682
710-189	FS CAT 550+580 91- , 09-681+683+687, -8182	09-681-683
710-193	FS CAT 800 3-CYL. 95-01, 09-602	09-602
710-216	FS CAT 594, 3-CYL. 95-02, 09-601	09-601
710-227	FS CAT ZR500, - 98, 09-605	09-605
710-262	FS CAT 800 2-CYL. 01- , 09-611	09-611
710-266	FS CAT ZL600, 01-02, 09-609	09-609
710-267	FS CAT ZR700, 99-00,	09-
	Rotax Ski-Doo Lynx Trapper Nordik	
710-022X	FS ROTAX 640 74- , 09-762-763	09-762-763
710-023A	FS ROTAX 377, -89, 09-751	09-751
710-023C	FS ROTAX 377, 90-95, 09-751, 841-80238	09-751
710-024	FS ROTAX 250, 71-96, 09-740, ELAN, 8024	09-740
710-025	FS ROTAX 440 (467) 71- , 09-761	09-761
710-026	FS ROTAX 340 76- , 09-747-748	09-747-748
710-119	FS ROTAX 250 TWIN, 73- , 09-745	09-745
710-162A	FS ROTAX 503 -95, 09-741, 841-8162	09-741
710-162B	FS ROTAX 503 -90, 09-741 , 841-8162	09-741
710-162C	FS ROTAX 447 -95, 09-752, 840-8124	09-752
710-163A	FS ROTAX 454 BLIZZ, 79- , 09-760	09-760
710-164	FS ROTAX 253, 85-93, 09-741, 841-8123	09-741
710-165	FS ROTAX 521, 09-741	09-741
710-165C	FS ROTAX 467, -95, 09-761	09-761
710-177	FS ROTAX 536 , 89- , 09-741	09-741
710-178C	FS ROTAX 583 -95, 09-772	09-772
710-194	FS ROTAX 582, -95 , 09-772	09-772
710-195	FS ROTAX 277, 1996- 09-741	09-741
710-196	FS ROTAX 503 FC 95- , 09-741, O-RENGAS	09-741
710-197	FS ROTAX 670, 93-95, 09-773	09-773
710-203	FS ROTAX 467 , 94-96, 09-761	09-761
710-210	FS ROTAX 380, 440, 1996- , 09-751, 09-752, O-	09-751-752
710-211	FS ROTAX 454, 95-97, 09-760	09-760
710-212	FS ROTAX 494 LC, 96-01, 09-780	09-780
710-213	FS ROTAX 599, 3-CYL. 09-774	09-774
710-214	FS ROTAX 599, 3-CYL. 09-774	09-774
710-215	FS ROTAX 670, 95- , 09-773	09-773
710-221	FS ROTAX 800 97-01, 09-782	09-782
710-222	FS ROTAX 700, 97-00, 09-781	09-781
710-235	FS ROTAX 600 , 99- , 09-785	09-785

Engine gaskets, professional, without oil seals

Number	Rotax Ski-Doo Lynx Trapper Nordik	Piston
710-255	FS ROTAX 700, 00-02, 09-783	09-783
710-256	FS ROTAX 493, 00-05, 09-784	09-784
710-259	FS ROTAX 593 RAVE, 09-785	09-785
710-261	FS ROTAX 800 , 02-03	
710-277	FS, ROTAX 552, 03---, 09-779	09-779
710-278	FS ROTAX 594 HO 03-05, 09-776	09-776
	Polaris	
710-069	FS POL 244, ALL, 09-700, 840-8069	09-700
710-070	FS POL 250 74-78, 09-702	09-702
710-071	FS POL 250, 76-89, 09-703	09-703
710-073	FS POL 340 77-81, 09-708	09-708
710-075	FS POL 340 73-82, 09-706	09-706
710-078	FS POL 440 75-81, 09-704	09-704
710-079	FS POL 440 75-80, 09-705	09-705
710-109C	FS POL 400 2-CYL. 84-91, 09-707	09-707
710-110	FS POL 600 3-CYL. 84-87, 09-707	09-707
710-110A	FS POL 440 82-99, 09-710	09-710
710-110C	FS POL 488 FC 86-99, 09-712, 840-81108	09-712
710-173	FS POL 340, 86-93, 09-709 JA 94-, 09-717	09-709
710-181A	FS POL 650 88-97, 09-713, 840-8187	09-713
710-185A	FS POL 488 LC, 89-02, 09-711, 840-8188	09-711
710-186	FS POL 440 FC 91-99, 09-710	09-710
710-191	FS POL 580 93-94 , 09-714	09-714
710-204	FS POL. 94-97, 09-716	09-716
710-205	FS POL 600 3-CYL. 95-00, 09-716	09-716
710-206	FS POL 679 3-CYL. 96-97 , 09-718	09-718
710-231	FS POL. XC700, 98-01, 09-721	09-721
710-238	FS POL FC 550, 99- , 09-727	09-727
	Yamaha	
710-027A	FS YAMAHA 250 BRAVO 84- , 09-800	09-800
710-140A	FS YAMAHA 535, 83-91, 09-816	09-816
710-142	FS YAMAHA EX 340 81-88, 09-802	09-802
710-142C	FS YAMAHA 340 , 89- , 09-802	09-802
710-146	FS YAMAHA EX 440 76-81, 09-806	09-806
710-147C	FS YAMAHA SS440 80-83, 09-807	09-807
710-167	FS YAMAHA 535 CC SRV 82-90, 09-808	09-808
710-167A	FS YAMAHA 540,540 SRV 85-90	09-808
710-168	FS YAMAHA PZ 480 84-90, 09-813	09-813
710-168B	FS YAMAHA 485 CC, -07, 09-813	09-813
710-171	FS YAMAHA 570 -90, 09-817	09-817
710-171A	FS YAMAHA 570 CC, 91-, 09-817	09-817
710-182	FS YAMAHA 535 VIKING 92- 07, 09-808	09-808
710-200	FS YAMAHA 494 CC 94-96, 09-825	09-825
710-201	FS YAMAHA 598 CC 94-95, 09-826	09-826
710-239	FS YAMAHA 485 CC, (500) -07 09-813	09-813

Piston

Arctic Cat	dia	cc	gasket	needle cage	oil seal magneto	oil seal clutch
EXT 600 Triple 97-98; EXT 600 Tr. Touring 1998; Powder EXT 600 1997-98; ZRT 600 1995-98 09-601	66,50	594		35-503	09-14618	09-14619
Pantera 800 1998-01; ZRT 800 1995-01 09-602	72,00	794		35-523	09-14618	09-14619
ZL 500 EFI 1998-01; ZR 500, ERSI 1998-01; Powder SP 500 EFI 1999-01 09-679	71,00	497		35-523	09-14618	09-14619
EXT 580 MC; EXT 580 EFI MC 1993-97; 580 Powder SP 1995-97; ZR 580 1993-97; Pantera 580 1995-97 09-681	75,40	580		35-523	09-14618	09-14619
Wildcat 700 MC. EFI 1991-96, ZR 700 1995 09-682	81,00	699		35-523	09-14618	09-14619
EXT special 1991-92; EXT Mountain Cat 1991-92; EXT 550 EFI, EFI Mtn Cat 1993-94 Bear Cat 550WT 09-683	73,40	550	840-8182-9	35-523	09-14618	09-14619
Panther, Puma, Cheetah, Pantera 1971-1974 09-685	60,00	339				
Bearcat 550 1995-98; Cheetah 550 1994; Cougar 550 1995-98; EXT 550, EFI 1993-98; Pantera 550 1993-94; Panther 550 1997-98; Prowler 550 1995 09-687	73,40	550		35-523	09-14618	09-14619
El Tigre 440 Z 1975-77; Kawasaki Intriguer, Intruder, Invader; Drifter 440 1978-81 09-689	68,00	440	840-8059-9	35-522	09-14603	09-14603
Cheetah FC, Cougar 1986-90 09-691	70,00	500	840-8061-9	35-503	09-14603	09-14603
Bearcat 340 1995-01; Cheetah 340 1994; Jag 340 1976-77, 1987-90; Jag 3000 FA, FC 1978-80 Jag Deluxe 1987-90; Jag Mountain Cat 1990-91; Jag 340 DeLuxe 1998-99; Panther 340 1998-01 Trail Cat 3000 FC 1980; Manx, Manx Deluxe 1991-93; Manx Mountain Cat 1992-93; Puma DeLuxe 1994-97 09-692	60,00	339	840-80588-11	35-502	09-14603	09-14603
Cheetah 5000 1976-78; El Tigre 500 1976; El Tigre 5000 1977-81; Pantera 5000 1976-81; Panther 500 1976 Cougar Spec. Edition 1985; Panther 1986-88; Pantera el. 1980; Manx 2000S 1977-80 09-693	70,00	500	840-8061-9	35-503	09-14603	09-14603
El Tigre 6000 LC 1980-85 09-694	70,00	500	840-80632-14	35-503	09-14603	09-14605
El Tigre 6000 LC 1978-79; El Tigre Cross Country 1979; Pantera LC 1985-92; El Tigre 5000 LC 1987 Jag 440 LC 1987; Panther 440 LC 1996; ZL 440 1997-99; Prowler 1990-94; Cheetah Touring 1991-93; Cougar 1991-94. 09-695	68,00	440	840-8181-13	35-503	09-14603	09-14603
Bearcat 440 1995-01; Cheetah 440 1994; Panther 4000 FC 1980-81; Trail Cat 4000 FC 1980-81; Jag 4000 FC 1980-81; Jag AFS LT 1991-93; Jag FC 1985-87; Jag 440 DeLuxe 1988-99 Jag 440 Z 1991-96; Panther DeLuxe 440 1984-01; Z 440 ES 1990-01; Super Jag 1991-92 09-696	65,00	431	840-80607-10	35-502	09-14603	09-14603
Cheetah LC 1986-89; El Tigre 6000 1986-89; El Tigre EXT 1989-91; El Tigre Ext Mountain Cat 1990 09-699	72,00	529	840-80632-14	35-503	09-14603	09-14603

Piston

Ski-Doo	dia	cc	gasket	needle cage	oil seal magneto	oil seal clutch
Spirit 250 1976-78; Elan 250 E 1971-78						
09-740	69,00	247	840-8119-9	35-505	09-118	09-118
09-740-02	69,50					
09-740-04	70,00					
Spirit 250 1979-83; Elan 250 1979-96						
09-740-02	69,50	250	840-8024-9	35-505	09-118	09-118
09-740-04	70,00					
Rotax 253, 277, 503,521,536 Lynx, Nordik, Ockelbo, Skidoo, Trapper, Winha						
09-741	72,00	253	841-8123-8	35-505	09-126	09-146
09-741-01	72,25	277	841-8300-9	35-505	09-168	09-169
09-741-02	72,50	503	840-8162-8	35-505	09-165	09-167
09-741-04	73,00	521		35-505	09-167	09-165
09-741-06	73,50	536	840-8170-20	35-505	09-167	09-165
Olympic 320, 320E 1969; Olympic 300, S, M, 1971-77						
09-742	76,00	319		35-505	09-118	09-118
09-742-02	76,50					
Elan 250 1973-79						
09-745	54,00	247		09-514	09-118	09-118
Olympic 335 1969-72; Skandic 1970-73						
09-746	78,00	335		35-505	09-118	09-118
TNT 340, 1972-76; Olympic 340, E 1975-79; Everest 340, E 1977-79; Futura 340 1975; Nuvik 340, E 1976-79						
09-747	59,5 left	339		35-505		
09-748	59,5 right	339		35-505	09-167	09-167
Blizzard 6500 Plus, 7500 Plus, Cross Country 1978-81; Super Sonic 1979-81						
09-750	59,50	339		35-505	09-165	09-167
09-750-02	60,00					
Rotax 377 ; Lynx, Nordik, Ockelbo, Skidoo, Trapper, Winha						
09-751	62,00	377	840-80238-7	35-505	09-165	09-167
09-751-01	62,25					
09-751-02	62,50					
09-751-04	63,00					
Rotax 447; Lynx, Ockelbo, Skidoo, Trapper						
09-752	67,50	447	840-8124-11	35-505	09-165	09-167
09-752-01	67,75					
09-752-02	68,00					
09-752-04	68,25					
Everest 440 FC 1974-79; TNT 440 FC 1975-78; Olympic 1977; Futura 440 1975-79; Nuvik 440 1977						
09-758	67,5 left	436,6		35-505	09-122	09-116
09-758-02	68,00					
09-759	67,5 right	436,6		35-505	09-167	09-167
09-759-02	68,00					

Piston

Ski-Doo dia cc gasket needle cage oil seal magneto oil seal clutch

Blizzard 9500 1979-82; Ultra Sonic 1980-82

09-760	67,50	436,6		35-505	09-167	09-167
09-760-01	67,75					
09-760-02	68,00					

Rotax 444, 467; Elite 450 LC 1978-79; Everest 444 LC 1978-79; Everest 464 LC 1980-83; SS-25 1984 Grand Tour. 470 1995; Formula SS 1985; Formula St 1994; Formula SP 1985-86; Formula MX, LT, XTC 1985-95 Formula MXZ 1993-94; Safari GLX, LC, LCE 1990-92; Summit 470 1994-95

09-761	69,50	436,6		35-505	09-167	09-167
09-761-01	69,75					
09-761-02	70,00	462,8		35-505	09-167	09-165
09-761-04	70,50					

Alpine 640 1969-82; Nordic 640 1970-74; TNT 640 1971-72; Valmont 1971-72

09-762	76,00 left	635		35-505	09-103	09-103
09-762-02	76,50					
09-763	76,00 right	635		35-505		
09-763-02	76,50					
09-763-04	77,00					

Rotax 583, 621; F Mach 1, XTC 1989-92; F Plus, E, XTC, X 1992-93; F Plus EFI 1993-94; F GT 580 1993-96; F STX 1994-96; Summit 1994-96; F Z 1994-96

09-772	76,00	583		35-505	09-167	09-165
09-772-01	76,25					
09-772-02	76,50	617			center	09-16002
09-772-04	77,00					

Rotax 670; Mach 1 X 1993; Mach 1 1993-96; MXZ 670 1996-99; GT SE 1994-96; F SS 670 1995-96; Summit 670

09-773	78,00	669		35-524	09-167	09-165
09-773-01	78,25					
09-773-02	78,50					
09-773-04	79,00					

Formula 3 600 1995-97

09-774	64,50	600		35-503	center 09-11301	09-165 09-170
---------------	-------	------------	--	--------	--------------------	------------------

Rotax 500, 780; F Z 500 1999; F 500, DLX, SLS 1996-00; GT 500 1996-99; Mach Z 780 1993-97; MXZ 500 98-Scandic WT LC 1999-00; Summit 500 1996-99; Touring 500 LC 2000

09-780	69,50	500		35-505	09-165	09-165
09-780-02	70,00	779	center	09-165 or 09-16003	09-11301	09-170

Rotax 700; F 3 700 1998-00; GT 700 1998-00; GT SE 1997-98; Mach 1 700 1997-00

09-781	69,80	699		35-503	09-11301	09-170
---------------	-------	------------	--	--------	----------	--------

Mach Z 800 1997-99; F 3 800 1999

09-782	70,50	796		35-503	center 09-170	09-16003 09-170
---------------	-------	------------	--	--------	------------------	--------------------

Formula 700, Legend 700, MXZ 700 Summit 700 2000-2002

09-783	78,00	700				
---------------	-------	------------	--	--	--	--

Formula 600 1999-01, Formula 600 GS 2001, Formula Z 1999-00, GT 600 1999-01, MXZ 600 1999-02 Scandik 600 WT L/C 2001-02, Summit 600 1999-01, GT 600 GS, SE, Sport, Legend 600 2002 MXZ 600 Adr., Renegade, Sport, Trail, RER Sport, Sport 2002, Lynx 600 L/C mallit

09-785	76,00	597				
09-785-02	76,50					

Piston

Polaris dia cc gasket needle cage oil seal magneto oil seal clutch

Charger, Mustang 488 1971; Voyager 488 1971; Colt 250 1972-78; Custom 2 1971; TC 250 1974-75; Electra 250 1975-77; Gemini 244 1979-83; Star 1983-90; Startrak 1987-90; Starlite Gt 1991-95

09-700 72,00 **488** 840-8069-935-520 09-14102 09-14102
09-700-02 72,50 **244**
09-700-04 73,00

Colt 250 1976-78

09-702 53,50 **250** 35-520 09-14103 09-14102

Starfire 250 1976; TX 250 1976-79

09-703 53,40 **250** 35-520 09-14103 09-14102

TX 440 1973; Electra 440 1974-77; Cobra 440 1978-79; Galaxy 440 1980-81; Cutlass 440, E 1981-82; TX-C 440C 1981; Long Track 1983-86; Sport, Super Sport SS 1983

09-704 67,72 **432** 840-8110-10 35-520 09-140 09-140
09-704-02 68,22 09-14202 09-14202

TX 440 1976-80

09-705 67,75 **440** 35-520 09-140 09-140

Indy 400 1984-1991; Indy 600 1984-87

09-707 65,00 **398, 597** 35-503 09-14202 09-14202
09-707-01 65,25
09-707-02 65,50
08-707-04 66,00

Colt SS 340 1977; Cobra 340 1978-79; SS 340 1979; Apollo, Galaxy, Cutlass 340 1979-1981

09-708 61,78 **333** 840-8109 35-520 09-14102 09-14102
09-708-02 62,28

Sprint ES 1986-90; Indy Sport, GT 1987-90; Indy Lite, GT, Starlite 1991-93

09-709 62,25 **339** 840-81087-7 35-503 09-14202 09-14202
09-709-01 62,50
09-709-02 62,75

TXC 440 FC 1982; Indy Trail 1983-1986; Long Track 1984-90; Indy Sport 1991-98; Sport GT 1991-93 Sport Touring 1995-98; Super Sport 1995-96; Transport 1996-98

09-710 67,75 **440** 35-503 09-14202 09-14202
09-710-02 68,25
09-710-04 68,75

Indy 500 LC, Classic 1989-00; Indy 500, SKS, SP, 1990-98; Indy 500 EFI 1992-98
 Indy Classic Touring 1993-94; Indy Widetrack 1997-98

09-711 72,00 **488** 840-8188-14 35-503 09-14202 09-14202
09-711-01 72,25 841-8188-18
09-711-02 72,50
09-711-04 73,00
09-711-06 73,50

Piston

Polaris	dia	cc	gasket	needle cage	oil seal magneto	oil seal clutch
Indy Trail FC 1986; Indy Tr. DeLuxe 1988-92; Super Sport 1997-98; Supertrac 1991-93; Indy Trail, Touring 1994-99						
09-712	72,00	488	840-81108-9	35-503	09-14202	09-14202
09-712-01	72,25					
09-712-02	72,50	Käytä 09-711 mäntää				
09-712-04	73,00					
Indy 650, SKS 1988-93; Indy 650, RXL, SKS, 1990-97						
09-713	67,75	648	840-8187-15	35-503	09-14202	09-14104
09-713-01	68,00					
09-713-02	68,25					
09-713-04	68,75					
Indy 580 XLT, SKS, XLT SP 1993-94						
09-714	64,00	579		09-525	09-14202	09-14202
09-714-01	64,25					
09-714-02	64,50					
Indy 440 XC 1992; Indy 440 XCR 1993-94; Indy Trail DeLuxe 1993						
09-715	67,72	440		35-525	09-14202	09-14202
09-715-01	67,97					
09-715-02	68,22					
Indy XLT 600 1995-98; XLT SP 1997-98; Indy XCR 600 1995-97; XC 600 1997						
09-716	65,00	597		09-525	09-14202	09-14202
09-716-01	65,25					
09-716-02	65,50					
Indy Lite, DeLuxe; Indy Lite Gt 1994-98; Indy Lite Touring 1998						
09-717	62,30	340	840-81087-7	35-525	09-14202	09-14202
09-717-01	62,55					
09-717-02	62,80					
09-717-04	63,30					
Indy Ultra SP, Ultra SPX, SE, Ultra Touring 1996-97						
09-718	66,50	679		35-503		
Indy Storm 800 1994-98						
09-719	72,00	794				
RMK 500, SKS 2000-02, 500 XC1999-02, Indy500 99						
09-720-02	71,00	500				
Indy 600 Classic, Touring 2001, Indy 600 Touring 2000, 600 XC SP, Edge 2000, 600 XC SP 2001						
09-728	77,25	600				
Kohler	dia	cc	gasket	needle cage	oil seal magneto	oil seal clutch
Kohler 340 engine						
09-670	62,00	340	840-8092-10	35-520	09-104	09-113
09-670-01						
09-670-02						
09-670-04						
	dia	cc	gasket	needle cage	oil seal magneto	oil seal clutch
Sachs						
Sachs 440 engine						
09-SM127	67,40	436			09-116	09-127

Piston Yamaha

dia cc gasket needle cage oil seal magneto oil seal clutch

Br 250 1982-94; Br 250T, TS, 1985-00; BR 250 TS 1984-97

09-800	70,00	246		35-525	09-131	09-14305
09-800-01	70,25					
09-800-02	70,50					

ET 250,1977-1981

09-801	72,96	246		35-505		
09-801-01	73,21					
09-801-02	73,46					
09-801-04	73,96					

EC 340 1982-88; ET 340 1978-88; CS 340 E 1989-00

09-802	60,00	337	840-8145-11	35-522	09-131	09-132
09-802-01	60,25					
09-802-02	60,50					
09-802-04	61,00					

GP; TL, 433 1975; EX 440 1976-81; GP 440 1976-78; PR 440 1976-77; STX 1976-77

09-806	68,00	433	840-8028-8	35-505	09-143	09-135
09-806-01	68,25					
09-806-04	69,00					
09-806-06	69,50					

SS 440 1980-83

09-807	66,00	440		35-505	09-143	09-137
09-807-02	66,50					

EC 440 1979-84; SR 540 1980-91; XL 540 1985-90; VK 540 1988-00

09-808	73,00	535	840-81401-14	35-521	09-143	09-137
09-808-01	73,25					
09-808-02	73,50					
09-808-04	74,00					

PZ 480E, PZ 480 1984-98; PZ 480 ST 1991-98; VT 480 1991-97; VT 480 GT 1993-97; VT 480 TF/XL 1993-00 Phaser 500 1999-00; Phaser 500 ML 2000; Phaser Mountain 480 1999; Venture 500 1999-00

09-813	72,00	485	840-81363-11	35-505	09-14303	09-14302
09-813-01	72,25					
09-813-02	72,50					
09-813-04	73,00					

VMX 540 1983-91

09-816	73,00	535		35-521	09-14306	09-14301
---------------	-------	------------	--	--------	----------	----------

Exciter 570 1987-90; Exciter 2 1991-92

09-817	73,00	569	840-81261-11	35-521	09-14313	09-14301
09-817-02	73,50					
09-817-04	74,00					

V-Max 500 LE, DX, ST, 1994-96

09-825	68,00	493		35-521		
---------------	-------	------------	--	--------	--	--

V-Max 600, LE, DX, ST, 1994-96

09-826	74,80	598		35-521		
09-826-02	75,30					

Ring set

Rotax 503-253

10-741-00
10-741-01
10-741-02
10-741-04

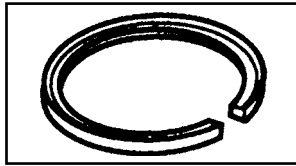

Piston pin

Rotax 377

10-751-00
10-751-01
10-751-02
10-751-04

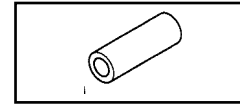

11-741
11-751

Gaskets



08-101

Rotax 377-447-503

manifold

08-100

Rotax 377-447-503

carburetor

08-102

Polaris

manifold

Repair kits

(MIKUNI)



08-103

Mikuni (07-187-05)

08-104

Mikuni (07-187-11)



03-7000

Primer pump



03-7311

In tank filter

Spark plug

BOSCH



05-B8 BR8ES

resistor type

05-B9 BR9ES

resistor type

Fuel pumps



31 l.

08-188



70 l.

08-200



08-187

Sprockets Silent Chain

Sprockets / Arctic Cat, Polaris 13 splines, dia 24 mm

11 links wide

45-016	16 t
45-017	17 t
45-018	18 t
45-019	19 t
45-020	20 t
45-021	21 t
45-022	22 t
45-023	23 t
45-024	24 t

13 links wide

46-016	16 t
46-017	17 t
46-018	18 t
46-019	19 t
46-020	20 t
46-021	21 t
46-022	22 t
46-023	23 t
46-024	24 t

15 links wide

49-016	16 t
49-017	17 t
49-018	18 t

Sprockets / Skidoo 15 splines, dia 26 mm

11 links wide

47-016	16 t
47-017	17 t
47-018	18 t
47-019	19 t
47-020	20 t
47-021	21 t
47-022	22 t
47-023	23 t
47-024	24 t

13 links wide

48-016	16 t
48-017	17 t
48-018	18 t
48-019	19 t
48-020	20 t
48-021	21 t
48-022	22 t
48-023	23 t
48-024	24 t

15 links wide

50-016	16 t
50-017	17 t
50-018	18 t
50-019	19 t
50-020	20 t
50-021	21 t
50-022	22 t



Silent Chain
11 links wide

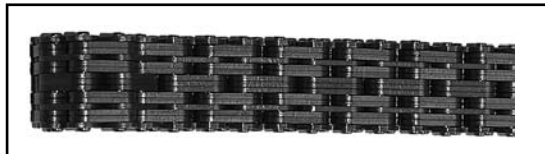

13 links

15 links

45-064	64 l	46-064	64 l	50-064	64 l
45-066	66 l	46-066	66 l	50-066	66 l
45-068	68 l	46-068	68 l	50-068	68 l
45-070	70 l	46-070	70 l	50-070	70 l
45-072	72 l	46-072	72 l	50-072	72 l
46-074	74 l	46-074	74 l	50-074	74 l

Brake pads

Yamaha



05-15224 pair



05-15228 pc



05-15245 pc



05-15249 pair

Brake pads

Arctic Cat

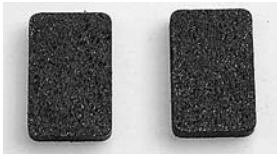

05-15225 pair
AC 0109-932

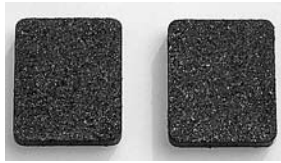

05-15232 pair
AC 0115-603



05-15240 pair
AC 0702-264

Polaris



05-15241 pair
AC 0702-229

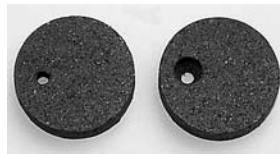

05-15203 pair
Pol 193034/5



05-15214 pc
Pol 1930 569



05-15231 pc
Pol 1930 588



05-15237 pc
Pol 1930 586



05-15243 pair
Pol 1930 723

Ski-Doo Lynx

Nordik



05-15212 pair
Sk 860.701.400



05-15235 pair
Skidoo, Lynx, Nordik



05-15247 pair
Sk 860.701.700



05-15241 pc
Sk 414.933.700
Lynx

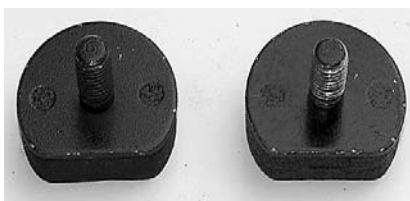

05-15242 pair
Sk 860.700.700
Lynx



05-15246 pc
Sk 414.990.000
Lynx

Windshields

Note: always measure the height of the windshield from the light opening along the surface.

00-110	5 393 062	GL 250 - >88
00-111	524090X	GL 250 S, GL 230 89->91
00-112	526754	GL 360 S 92->95
00-115		539504 Forest Fox 96->98, 01
00-120	522842X	GL 3900, GLX 5900 steel brackets->93
00-121	538284-1	GLX 5900, with srcews 1995
00-122	523192X	GLS 3300 low
00-123	538616	GLX 5900, 1995
00-130	524126X	GL 3300, GL 3900 S, 88->92
00-131	526976	COBRA 1992
00-132	527091	COBRA 1992->93
00-133	538837	COBRA 94->95, ULTRA 94->96
00-140	5393890-1	640
00-141	6500202-2	650 with screws 1995
00-142	533084X	650 steel bracket 83->94
00-151	537644	RANGER, LIGHT, GT 93->97
00-161	5241171	RANGER; LIGHT high
00-171	5241478	G-TYPE, black 1997-00
00-172	5143618	G-TYPE, G-TOUR, Sport XR , low
00-173	5143619	G-TYPE, XR 500 F, G-TOUR: medium
00-181	5241686	GLX 5900 96->99, 6900 1997
00-300	Nordik 300	
00-377	Nordik 377 R	
00-500	Nordik 500, 600, 7 slots	
00-510	Trapper, 5000, 5 slots	
00-550	Nordik 550	

Original production.

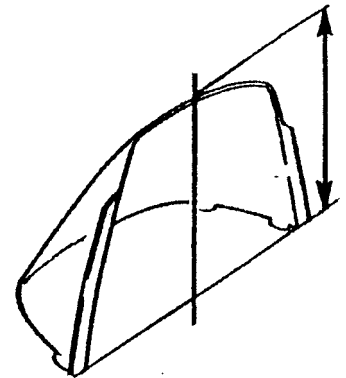

Mirror 12-165 pair

CDI-Boxes



01-14342
Rotax 410.918.900



01-14343
Rotax 420.965.591



01-401
Arctic Cat 3004-099



01-14340
Rotax 420.866.595



01-415
Yamaha 8V0.85540.21



01-407
Polaris 3083725



01-14345
Rotax 420.965.757



01-40701
Polaris 3083989



01-40801
Polaris 3084007



01-14329
Arctic Cat 3003-777



01-14372
Skidoo 512.058.927 Form.

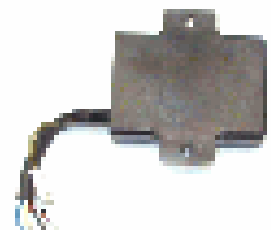

01-406
Pol. 3083721 600-650



01-404
Polaris 308 3723



01-14327
Arctic Cat

Ignition coils



01-14310
Rotax 410.916.000



01-14311
Rotax 410.913.500 Arctic



01-14319



01-14312
Arctic Cat 3003-221



01-14313
Polaris 3082974



01-143120
Arctic Cat 3003-977



01-14314
Yamaha 8W3.82310.10



01-14315
Yamaha 8E7.82310.10



01-14317
Yamaha 5.82310.40



01-14351
Yamaha 8AB.82310.10



01-14353
Arctic Cat 3003-575



01-14355
Rotax 10.920.500



01-14350
Yamaha Bravo 250 -88



01-14363
AC 3005-381 ZL-ZR 5-700



01-14371
Rotax 420.996.705
Form. III, Mach1, Z, ZR

Ignition coils



01-14360
Arctic Cat 3004-126



01-14361
Arctic Cat 3004-483



01-14362
Polaris 3084469



01-1430
Rotax, Bosch, Arctic Cat



01-14367
Polaris 3085293



01-14370
Formula 415.085.400

Safety stop swicth



01-113 Arctic Cat



01-11120
Skidoo



01-11121
Skidoo 515.1515.00

Ignition coil



01-14332
Bosch, Skidoo, Motoski



01-11113
Yamaha, Arctic Cat, Polaris

Voltage regulator

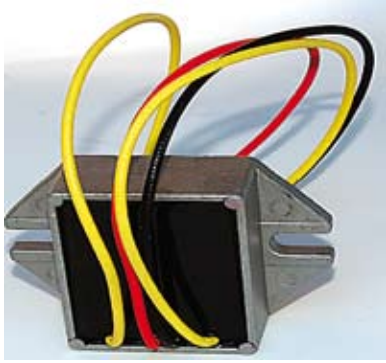

01-15416 **3 wires**
01-15416B **4 wires**



01-15402
 Rotax 410.908.900



01-15406
 Rotax, Arctic Cat



01-15417 **250 W**
 Tasasuuntaaja Rotax

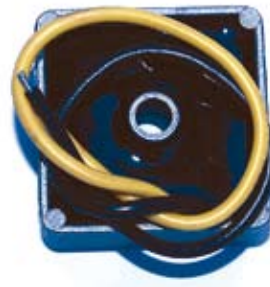

01-15415
 Rotax 410.908.900



01-15421
 Polaris 4060122



01-15418
 Tasasuuntaaja Arctic Cat



01-15426
 Arctic Cat 0232-014



01-15432
 Yamaha 82F.81910.



01-15435
 Yamaha 82M.81910.AO



01-15436
 Yamaha 98A.81910.00

Spark plug cap



01-110



384 cm



403 cm

All snow mobiles can be extended or changed to your liking. The sky is your limit! However, sometimes you need to consider if the changes are worth the effort. The decision is yours!

Please keep in your consideration that sometimes the original version has higher trade value than the one that has been extended.

Happy snowmobiling!

La Famiglia Biaudet
www.allimperatore.com
www.hotelpalu.com
+39 0465 440858
Madonna di Campiglio
Italy

