



Teo Lehtimäki Oy

**Version
française**



2014-2015

Mise à jour 13.04.2014



Catalogue de pièces 2013-2015

Dans ce catalogue, les produits du fabricant d'origine sont classifiés pour vous aider à choisir le produit de remplacement adéquat. Il se peut que notre produit soit fabriqué par un autre manufacturier.

Teo Lehtimäki Oy

Kaarronnevantie 54 61800 Kauhajoki Finland

Vesa Peltonen

cell. +358-40-5769111 Vesa Peltonen

fax +358-6-2311170

info@teolehtimaki.fi

vat. FI08350750

Teo Lehtimäki Oy

Vuopajantie 34 96400 Rovaniemi Finland

Artturi Lehtimäki

cell. +358-400-162110 Artturi Lehtimäki

fax +358-16-366004

Email personnel:

vesa@teolehtimaki.fi

Vesa Peltonen

artturi@teolehtimaki.fi

Artturi Lehtimäki

teo@teolehtimaki.fi

Teo Lehtimäki

Les questions financières

Vesa Peltonen

vesa@teolehtimaki.fi

www.teolehtimaki.fi

Content

- 4 - 6 Barbotins, Roues de support
- 7 Roulement à billes
- 8 - 9 Glissières
- 10 Axe transversal arrière, Attelage
- 11 Pignon Syncro
- 12-13 Ressorts, Pare-brise, Pompes
- 14-16 Ski extra large Blade, SLP ski
- 17-22 Lisse de ski
- 23 Poulie menée
- 24-29 P80, P50, ALT Poulie motrice, Trailbloc
- 30 Chaîne, Silent, Hyvo
- 31-35 Vilebrequin roulement à billes
- 36-39 Vilebrequins réusinés, shortblocks
- 40-42 Bielle de vilebrequin, Roulement à aiguilles
- 43-49 Wössner Pistons forgés
- 50-51 Nicasil Cylindres Replaqués
- 52 Sea-doo, roulement à billes
- 53 Épaulement de caoutchouc
- 54-60 Pistons, made in Taiwan
- 61 Démarreur électrique
- 52-63 Ensemble d'accessoires de frein
- 64-67 CDI, Bobine d'allumage,
- 68-80 Chenille Camoplast
- 81 Instruction for utility snowmobiles
- 82-84 Raccourcir/Rallonge



43-48 pistons motoneige

49 pistons Sea-doo



36-39 Vilebrequins réusinés

Ski extra large Vuotsolainen

Lisse de ski

	normal
	MM274
	carbide
Ski-Doo: Pilot DS2	31-10

	normal
	MM274
	carbide
Ski-Doo: Pilot narrow	31-04

	normal
	MM243
	carbide
Lynx: ADJ ski	31-03

	normal
	MM238
	carbide
Polaris: Pro Steer	31-09

	normal
	carbide
Polaris: Pro-Float Ski	N/A

	normal
	MM263
	carbide
Yamaha: Viper (cat)	31-02

	normal
	MM263
	carbide
Arctic Cat: 2013-	31-02

	normal
	MM290
	carbide
LYNX: Blade	31-11

	normal
	MM274
	carbide
Ski-Doo: Pilot DS3	N/A

	normal
	MM274
	carbide
Ski-Doo: Pilot L & R	31-03L&R

	normal
	check ski
	carbide
universal	31-01

	normal
	MM238
	carbide
Polaris: Gripper	31-09

	normal
	MM239
	carbide
Yamaha: Viking III	31-05

	normal
	2 runners
	carbide
Yamaha: N/A	N/A

	normal
	MM239
	carbide
Yamaha: Viking IV	N/A

Ski extra large

Vuotsolainen

Part number	largeur mm	note	Fits
31-00	250		Alpine,
31-01	250		modele universal
31-02	200		modele universal
31-03	225		plastic skis as , ADJ
31-03R/L	225		pilot ski, right-left
31-04	200		pilot narrow
31-05	225	with holes	Yamaha
31-09	225	holes, Polaris	Polaris, Arctic Cat
31-10	240	holes, new	Lynx, Skidoo DS2 pilot
31-11	230	holes, new	Lynx, SLP ski, Blade



Sur 70 cm de neige molle.
La coque doit glisser sur la
neige autrement vous serez
détrempé rapidement.

31-01

31-02

31-03

31-03R / 31-03L



Ski extra large

Vuotsolainen

31-04

31-05

31-09

31-10

31-11



Nouveau

Doublures de plastique pour skis métalliques



32-01

Arctic Cat



32-06

Arctic Cat



32-00

Ockelbo



32-11

Trapper, Nordik



32-99

Safari, Scandic 380



32-21B Formula, Snowexpert



32-61

Lynx



32-41

Polaris 1993-



32-51

Polaris -92, Ockelbo



32-81

Yamaha Viking



32-88

Yamaha Phaser 98-



32-91

Yamaha V-max 94-



31-01

Vuotsolainen

Doublures de plastique pour ski de plastique



33-40

Polaris



33-60 Skidoo / Lynx flex



33-20

CTRL ski,



33-50 Pilot, Modèle étroit



33-10

Arctic Cat



33-80 Yamaha SRX 1998-



33-90

Yamaha 2000 / Skidoo / Lynx



33-99 Yamaha RX-1

31-06 Cogue
6 x 800 x 1000 mm

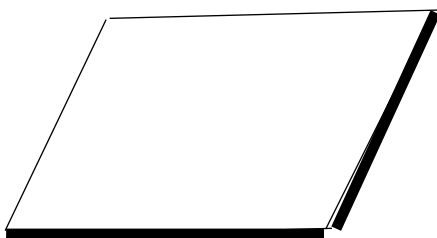

Also check....
www.teolehtimaki.fi

31-00 Alpine II

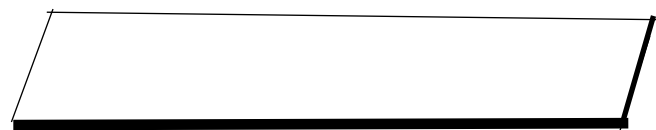
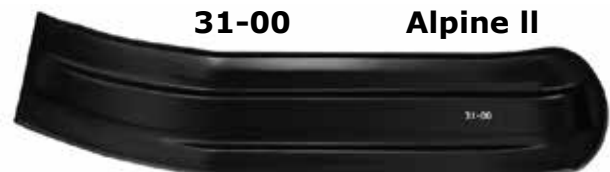

Plastique

31-07

8 x 150 x 3000

31-07A

8 x 300 x 3500

31-08

8 x 150 x 2000

No Slip Barbotins,

brevet par Wahl Bros.

Numero	Dents	Pas	Traction	Arbre / mm	Hexa
39-00	7	2,52"	136 mm	25,0-27,0	24,0 mm
39-01	7	2,52"	136 mm	27,0-29,0	26,0 mm
39-02	7	2,52"	136 mm	32,0-34,0	31,0 mm
39-05	8	2,52"	158 mm	25,0-27,0	24,0 mm
39-06	8	2,52"	158 mm	32,0-34,0	31,0 mm
39-08	8	2,52"	158 mm	27,0-29,0	26,0 mm
39-09	9	2,52"	177 mm	27,0-29,0	26,0 mm
39-10	10	2,52"	197 mm	27,0-29,0	26,0 mm
39-15	7	2,86"	155 mm	25,0-27,0	24,0 mm
39-16	7	2,86"	155 mm	32,0-34,0	31,0 mm
39-17	7	2,86"	155 mm	27,0-29,0	26,0 mm
39-18	8	2,86"	181 mm	27,0-29,0	26,0 mm
39-26	7	3,00"	163 mm	32,0-34,0	31,0 mm
39-27	7	3,00"	163 mm	27,0-29,0	26,0 mm
39-28	8	3,00"	190 mm	27,0-29,0	26,0 mm
39-38	8	2,86"	181 mm	Tube d'arbre	Polaris
39-39	9	2,52"	177 mm	Tube d'arbre	Polaris
39-41	7	2,86"	155 mm	Tube d'arbre	Ski-doo, Lynx
39-38	8	3,00"	190 mm	Tube d'arbre	Ski-doo, Lynx
21-08PO	8	3,00"	190 mm	Tube d'arbre	Polaris



Barbotins



Numero	Dents	Pas	Traction	Arbre / mm	Hexa
21-07N	7	2,52"	136 mm	carré	
21-07K	7	2,52"	136 mm	25,0-28,0	24,0 mm
21-08AC	8	2,52"	158 mm	25,0-28,0	24,0 mm
21-08LY	8	2,52"	158 mm	32,0-34,0	31,0 mm

Barbotins

Numero	Dents	Pas	Roulements	Usage
20-5285	9	50 mm	35-6205	Ockelbo, largeur 25 mm
20-5286	9	50 mm	35-6205	Ockelbo, Trapper, largeur 30
20-5287	11	50 mm	35-6205	Lynx, Nordik 300
20-5289	9	2,52"	35-6205	Chenille 9806, 9925, 9005
37-00	9	50 mm	-	Barbotins, largeur 22 mm
37-01	9	50 mm	-	Barbotins, largeur 30 mm
37-03	11	50 mm	-	Barbotins, largeur 30 mm
37-04	11	50 mm	hexa 27mm	Barbotins, largeur 30 mm
37-06	-	-	-	Pour galet d'acier 127 mm



37-06



20-5287



20-5289



20-5285



37-03



37-04

Important notice of the crankshafts

Important:

Always refer to the engine manufacturer shop manual for crankshaft installation.

Before closing the crankcase, make sure that the crankshaft fits firmly in the crankcase.

Before and after installing and torquing crank case bolts, be sure that the crankshaft turns smoothly. You must refer to the engine manufacturer for the proper bearing grease application. Bearings may be damaged if the grease is not applied properly.

Break-in-period:

There is never a more important period in the life of your engine than the break-in period. For the first 10 hours, do not put an excessive load on the engine. Avoid prolonged full throttle operation. Also avoid lugging the engine such as laborious operation in wet snow. If an abnormal condition is noticed, such as excessive vibration or noise, consult the engine manufacturer shop manual.

Warranty:

Rebuilt standard parts will be guaranteed for a period of one year starting at the invoice date.

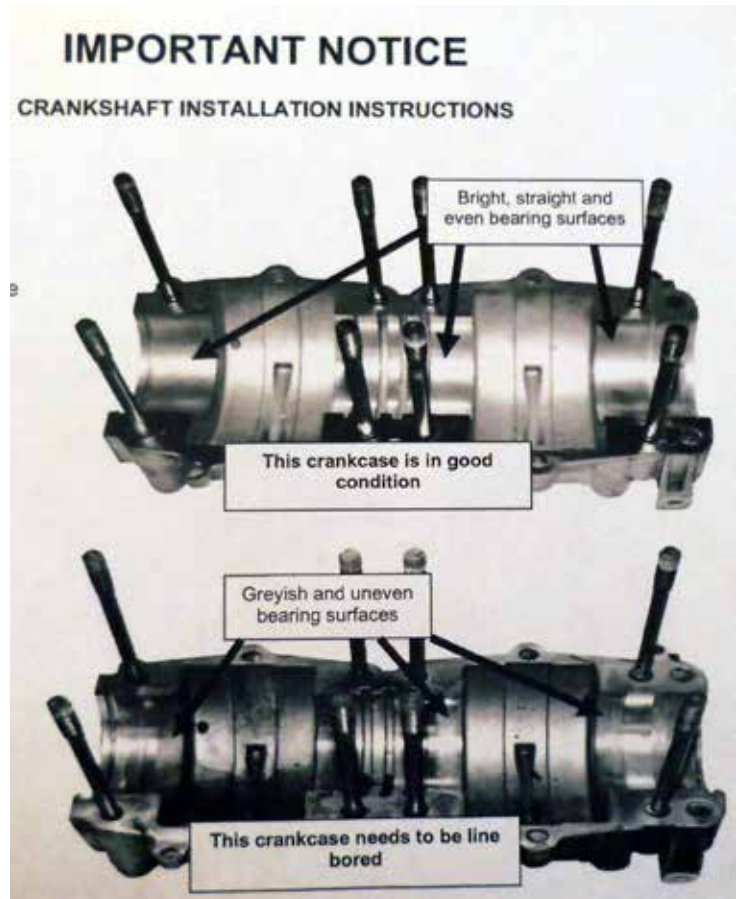

Roues de support

Numero	diameter	Roulements.	Couleur	Usage
20-82	082	35-620258	noir	
20-127	127	35-620258	noir	Lynx
20-130	130	35-6004	noir	Yamaha
20-133	133	35-6004	noir	Lynx, Ockelbo
20-135F	135	35-6205	argent	Pleine lune, Skidoo
20-135P	135	35-6304	argent	
20-5630H	143	35-6205	argent	Arctic Cat
20-6380H	160	35-6205	argent	Polaris, Arctic Cat
20-6375S	160	35-6205	bleu	Polaris, Arctic Cat
20-165H	165	35-6205	argent	Lynx
20-180	180	35-6205	argent	Lynx, 04-3000 flip
20-131	180	35-6204	noir	Yamaha
20-200	200	35-6205	noir	

Insert

20-34 insert 3/4 " couple

20-58 insert 5/8 " couple

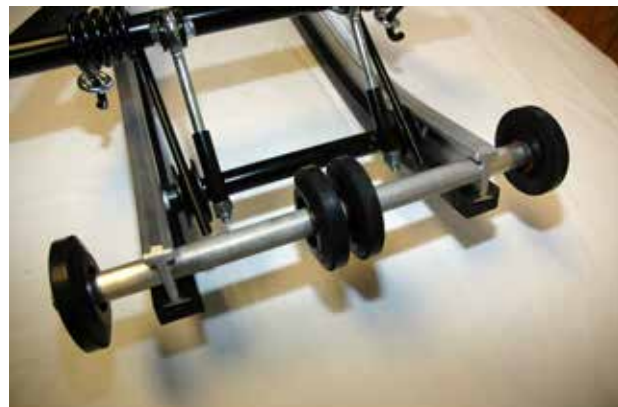

Anti-Stab wheel kit

Kit de roue Stab aider à prévenir suivre au harpon en empêchant l'entrée en chenille de contact avec le bout des rails de suspension.

39-791 Center, 223 mm arbre
Arctic Cat, Yamaha

39-793 Center, 220 mm arbre
Skidoo, Polaris, Lynx

Roulement à billes

Numero	hole	o dia	width
35-6201	12	32	10
35-6202	15	35	11
35-620258	15,875	35	11
35-6203	17	40	12
35-6204N	20	47	14
35-6205N	25	52	15
35-6303	17	47	14
35-6304	20	52	15



Numero	hole	o dia	width
35-CB205	25	52	15
35-SC205T	25,4	52	15



Numero	hole	o dia	width
35-UC205	25	52	17
35-UC205T	25,4	52	17



Numero	hole	o dia	width
35-30303			
35-3205	25	52	21



Numero	hole	o dia	width
35-6004	20	42	12
35-6005	25	47	12
35-6006	30	55	12
35-6008	40	68	15
35-6010	50	80	16
35-6022	22	44	12
35-6228	28	58	16

Numero	hole	o dia	width
35-SA205T	25,4	52	15



Numero	hole	o dia	width
35-SB205	25	52	15
35-SB205T	25,4	52	15



Numero	hole	o dia	width
35-RB205	25	52	15
35-AS205	25	52	15



Joint à rotule

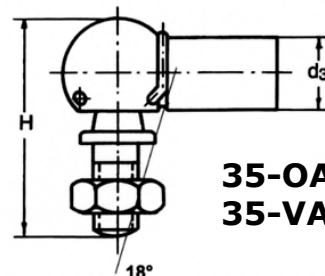

35-OAS16 M10 droit
35-VAS16 M10 gauche

Glissières

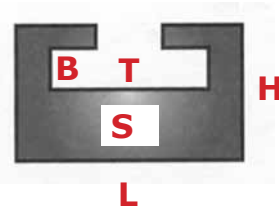

Arctic Cat	Width L mm		height H	thickn S	B ,mm	T ,mm
	30		20	9,5	5	19
	Number	length cm	color	Arctic Cat, tous les modèles après 78		
	30-10	140	noir			
	30-610	140	grafite	Yamaha Viper 2013-		
	30-167	167	noir	Arctic Cat, Super Jag, Karibo		

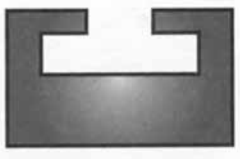
Skidoo, Lynx	Width L mm		height H	thickn S	B ,mm	T ,mm
	37,5		19	10	5	26
	Number	length cm	color			
	30-01	140	noir	Lynx, up tp G-type, and all		
	30-601	140	grafite	utility models		
	30-010	163	black	Skidoo old models up to -96		
Trapper, Nordik	Trapper, Nordik-300,500,600					

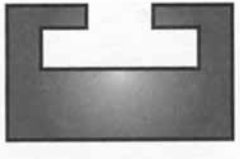
Skidoo Nordik	Width L mm		height H	thickn S	B ,mm	T ,mm
	37		20	10	7	24,5
	Number	length cm	color	Nordik 377 R, 540, 550		
	30-00	155	blanc			

Skidoo, Lynx	Width L mm		height H	thickn S	B ,mm	T ,mm
	38		17	9,5	4,5	22
	Number	length cm	color			
	30-21	140	noir	Lynx G-type-,		
	30-621	140	grafite	Skidoo REV, RT & RF, SC4 suspens.		
	30-210	163	noir			
	30-321	140	jaune			

Skidoo, Lynx	Width L mm		height H	thickn S	B ,mm	T ,mm
	38		15	7	5,4	27
	Number	length cm	color	Formulat, GT mod., Mach1, Z, MXZ,		
	30-260	140	noir	Legend, MX Rev, Summit, Renegade		
	30-270	151	grafite			
	30-280	163	noir			
	30-360	140	jaune			
	Lynx 2009- RS 600, SC 4 suspension,					

Glissières

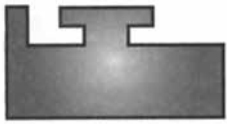
Polaris	Width L / L mm		height H	thickn S	B ,mm	T ,mm
	31	37		11		
	Number	length cm	color			
	30-15	140	noir	Up to 2000 all		
	30-615	140	grafite	XTRA 10, XTRA 12 narrow profile		
30-150	145	noir				
note: dimensions	30-618	140	grafite	Polaris- Storm, XCR, wide profile		

Polaris	Width L mm		height H / H	thic. S / S	B / B	T / T
	32		19,5	22,0	9 / 11	5 / 6
	Number	length cm	color	Edgr RMK 03-05, Edge 2000-05,		
	30-23	140	noir	340 mallit -99-05, Lite 97-98		
	30-623	140	grafite	Indy Sport -97-99,		
30-230	167	noir	2000-			
note: dimensions	30-240	163	noir	gen II RMK, XC, M-10 , Indy Edge		

Yamaha	Width L mm		height H	thickn S	B ,mm	T ,mm
	30			7		
	Number	length cm	color	Phaser, Ovation, SRV, SS		
	30-12	140	noir			
	30-612	140	grafite			

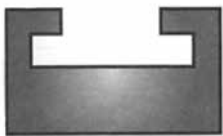
Yamaha	Width L mm		height H	thickn S	B ,mm	T ,mm
	30		15	7	5	24
	Number	length cm	color			
	30-16	140	noir	Viking, Exciter 87-90, Phaser 90-99		
	30-616	140	grafite	V-max 92-97,		
			V-max 500-600 94-96			

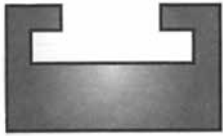
Yamaha	Width L mm		height H	thickn S	B ,mm	T ,mm
	30		18	10	5	24
	Number	length cm	color			
	30-20	140	noir	V-max 97-03,		
	30-200	145	noir	Mountain max 97-02		
30-620	140	grafite	SX, SRX, SXR, 98-04			

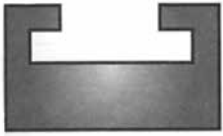
Yamaha	Width L mm		height H	thickn S	B ,mm	T ,mm
	34		18	10	5	25
	Number	length cm	color			
	30-625	145	grafite	RX1 models 2005- RS models 2005-		
	30-635	157	grafite	Apex, Attack 2006-		
			Nytro 2006-			



Arbre transversal arrière 5900

11-59 Arbre d'entraînement 5900

1989-1995 modeles



Rear shaft

11-08	5492814	essieu arrière	Lynx 250	
11-09	5493615	essieu arrière	Lynx 5900	
11-12	05032389	essieu arrière	Nordik 300, 377R	
20-5289		If there are the sprockets at the rear shaft, 9 or 11 tooth and external drive track: The only way to make a reparation is to replace a track and use sprockets 20-5289. They fit for internal drift, 2,52" pitch. And also		
		20-5289	50 cm track needs to use an idler wheel	
11-60	extension	connection part to extend the tube		
Arbre de renvoi				
11-20	5394111		Lynx 250S, 3900S	
11-21	5398073		Lynx 360S, Ranger	
11-22	539990		Fox -99	
11-23	5146138		Fox 00-	
11-25	875138073		Syncro connection part	

Attelage



12-01 Universal



12-02 Skidoo



12-03 Polaris



12-05 Nouveau, Lynx



12-04 Skidoo

12-04XP Skidoo -09-



Nouveau

43-27

Pignon **8751-46293**

Z = 27 1989-1997

Lynx 5900, 3900, 6900



43-68 600cc liquid cooled, L/C 2002-05

Pignon **Z=53 8751-56114**

Pignon **Z=31 8751-56156**

Pignon **Z=28 8751-56206**



43-32

Pignon **8751-46042**

Z = 32

1989-1996

Lynx 5900, 3900, 6900

Pignon Syncro

43-65 de 1992

Pignon du bas,
large

z=64 8751-55048

Pignon, G

z=33 8751-47643

Pignon, D

z=33 8751-47644

43-64 à 1992

Pignon du bas z=64 8751-55048

Pignon, G z=31 8751-47202

Pignon, D z=31 8751-47203



Nouveau



Pignon Sisu

43-66

1996-2003

Pignon Z=55 8751-56048

Pignon Z=31 8751-56049

Pignon Z=28 8751-56050

41-3000, 9mm	41-3281, 8 mm
	Lynx 250, 3900
	Lynx 5900

41-8797, 10 mm	41-8796, 9 mm
	Ranger, 5900, ym

Ab. 20% stronger	40-PZ
	12 mm
	Nytro
	Phazer 07-

Short wire longer than 40-PZ	40-LT
	Mt Lite

8-turns, 11,5 mm	40-POLA
	Polaris
	Skidoo
	Lynx

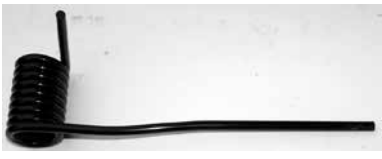
9-turns, 11,0 mm	40-PO
	Polaris 90-

Edge suspens, 11,0 mm	40-EDGE
	Polaris
	Skidoo
	Summit

Rear Spr.	40-4716
	Nordik 300
	Skidoo
	40-0310,
	Front spring

Front spr.	40-CA
	Karibo
	Arctic Cat

Like	
40-POLA	40-AC, 11,5 mm
	AC, newest
	40-VI, 12,0 mm
	Yamaha Viking

	41-1530, 9 mm
	Lynx 5900
	with ring
	40-4715, 8,5 mm
	Nordik 500-600

Ressorts arrières	41-8805
	Ranger
	Lynx 5900

Ressorts arrières	41-4175
	Lynx 3900

Ressorts arrières	41-4277
	Lynx 5900
	10,0 mm

Ressorts arrières	41-4500
	Lynx 5900
	9,0 mm

Ressorts arrières	40-4721
	Nordik 540
	Trapper
	41-1531
	Lynx 5900

With hook 11,5 mm	40-POL
	Polaris
	up to -89

All shown springs are right hand turned

Pare-brise

Note: toujours mesurer la hauteur du pare-brise à partir l'ouverture de la lumière en suivant la surface du capot

00-110	5393062	00-140	5393890-1
	GL 250 - >88		Lynx 640
00-111	524090X	00-141	6500202-2
	GL 250 S, GL 230 89->91		Lynx 650 screws. 1995
00-112	526754	00-142	533084X
	GL 360 S 92->95		Lynx 650 met. 83->94
00-115	539504	00-151	537644
	Forest Fox 96->98, 01		RANGER, LIGHT, GT 93->97
00-120	522842X	00-181	5241686
	GL 3900, GLX 5900 low->93		GLX 5900 96->99, 6900 1997
00-121	538284-1	00-300	Nordik 300
	GLX 5900, screws. 1995		
00-122	523192X	00-377	Nordik 377 R
	GLS 3300 low		
00-123	538616	00-500	Nordik 500, 600, 7 slots
	GLX 5900, slots 1995		
00-130	524126X	00-510	Trapper, 5000, 5 slots
	GL 3300, GL 3900 S, 88->92		
00-535	Lynx 535	00-550	Nordik 550, 540
	Lynx 535, all		

Pompes à carburant



31 l.

08-188



70 l.

08-200



08-187



Ensemble de rep. MIKUNI

08-103 Mikuni (07-187-05)

08-104 Mikuni (07-187-11)



Pompe d'alimentation

Filter à essence

Cliquet de Rotax



03-7000, no tube
03-7000A, w. tube



03-7311



01-154

Ressort de rappel

01-1560 Rotax 414 783 400

01-158 Rotax 420 939 115

01-2080 Arctic Cat 3001-077

Polaris 308-3185

01-207 Kohler









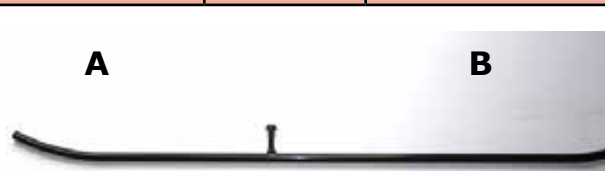
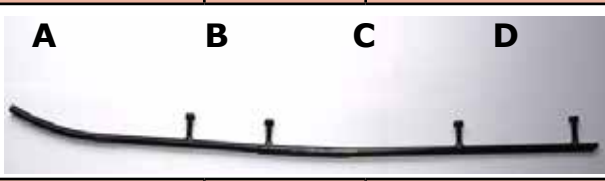

Accélérateur kit d'extension 20 cm 03-5000

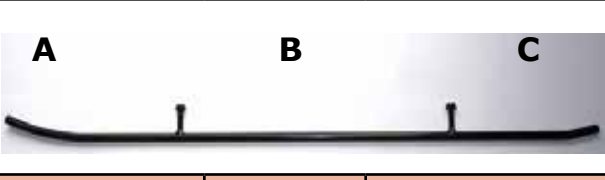
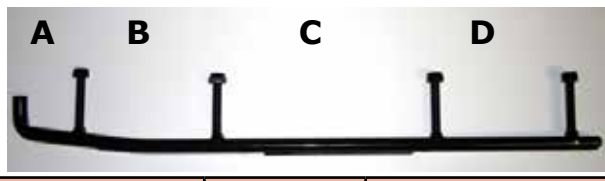
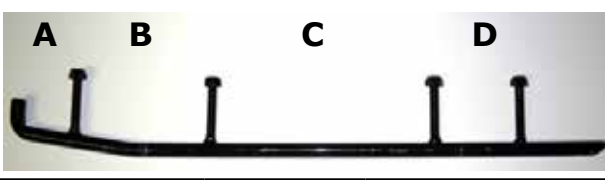

ARCTIC CAT

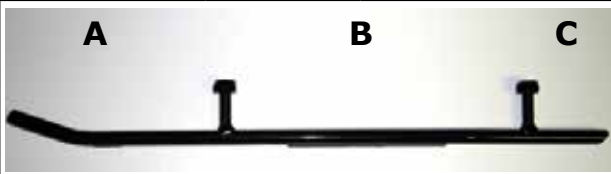
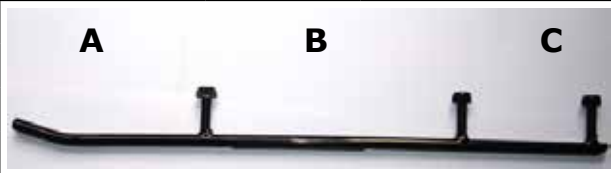
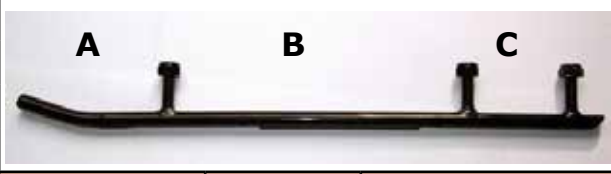
Lisse de ski

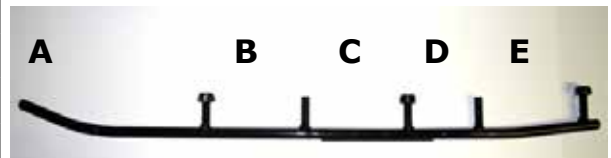
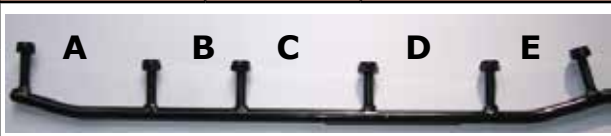
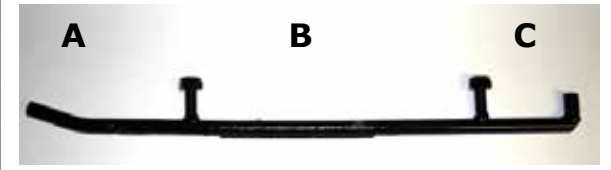

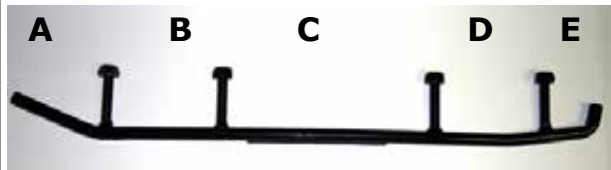

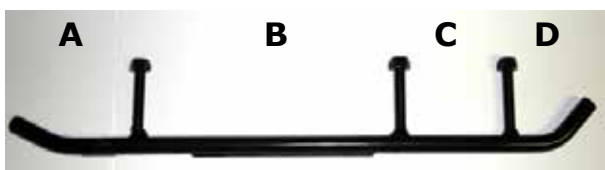
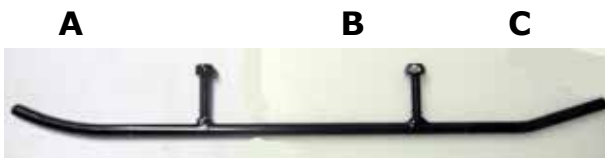
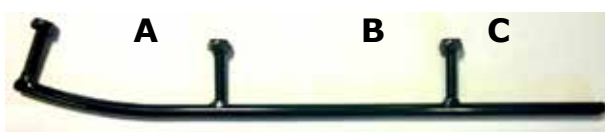
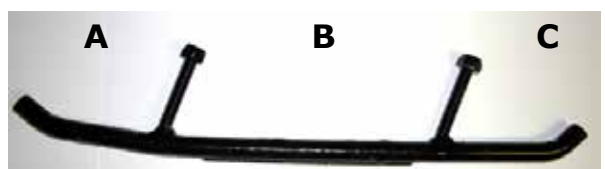
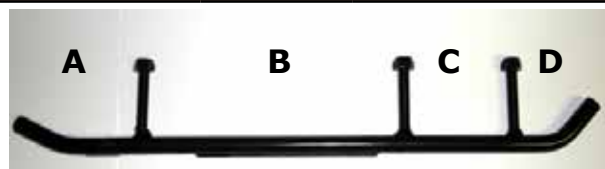
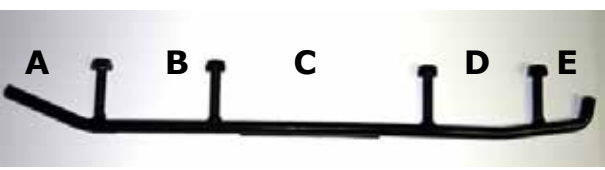
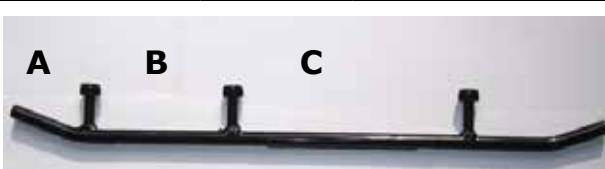
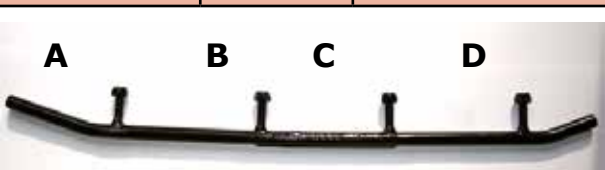

Normal	Racing	Carbide	L=longuer	A	B	C	D	E	
MM203		MM169	772	386	386	-	-	-	
			AKTIV: Alaska, Panther, Karibo 1984-1986, and also ARCTIC CAT: El Tigre 1980-84, Jag 1980-91, Panther 1980-89, Super Jag 1987-92 Trail Cat 1980-81, Pantera 1980-85						
MM205		MM170	776	343	433	-			
			Cheetah Tour 1987-91, Cougar 1987-91 El Tigre 1987-90, Jag AFS 1989-91 Manx 1991-, Pantera 1987-90 Panther 1990-91, Wild Cat 650 1988-90						
MM260		MM133	787	260	108	249	162		
			Ext Special 1992, Ext 580,Z 1993-94, Jag Special, Z 1992, Prowler Spec. 1992-94 Wild Cat 700 EFI 1992-94, ZR 440 1993-95 ZR 580,700 1993-95, Thunder Cat 1996						
MM210		MM173	610	356	127	114			
			Bear Cat 340,440 1995-99, Cheetah Tour 1992-94 Cougar 1992-97, Ext, EFI 1992-93, Manx 1992-93 Jag AFS DL 1992-93, Prowler 2-UP 1992-94 Pantera 1992-97, Panther 1992-93, Prowler 1991-96 Thunder Cat 1993-95 Puma 1991-97, Wild Cat EFI 1992						
MM261			791	236	380	193			
			El Tigre 1985-86 Cougar 1985-86 Cheetah 1986 Pantera 1986						
MM262		MM157	469	57	114	178	114		
			Ski de plastique 1996-						
MM263		MM158	469	57	114	178	70		
			Ski de plastique 2005-???						
SLP ski			SLP ski; BLADE						
MM290	MM390	MM190	470	89	179	90	112		
			SLP ski On the photos, the front of the runner is on the left side, always.						

Normal	Racing	Carbide	L=longuer	A	B	C	D	E	
MM242		MM189	470	170	235	65			
			Forest Fox 1999-, GL360, 250 1991-93, GL 2300 -90 GL 3300 1989-90, GL 3900, LTS 1991-92 GLS 3900 1989-90, GLX 5900, LTS 1991-93 GL Sport, LTS 1991-92, Ranger 1993						
MM230		MM187	550		235				
			GL 250. 250S 1986-89, GL 3900 1983-88 GL 5900 1983-90 535, 650 1983-87 640 1988						
MM240		MM188	450		228	81			
			GLS 3300 1986-89, GLS 3500 F/C 1990-93 GLS 3600 L/C 1990-91, Cobra 1992-93 3800 Rave, Ultra, Cobra Touring, Rave , Cobra Racing, Enduro 1993						
MM241			450		219				
			230, 250, 650 1989-93						
MM265		MM154	660	215	110	114	80	122	
			G-type Rave 1997-99 Enduro 600						
		MM153	530	120		115	110	80	
			G-type Racing 1998- Sport XR 98						
		MM152	440	130	228	77			
			G-type 1997-99 Enduro 500						
MM250		MM193	625	321	241	63			
			Ranger short steel ski of Skidoo 2000-						
MM279		MM146	537	90	103	190	103	54	
			FLEX Ski de plastique 2000- Fit also Skidoo						

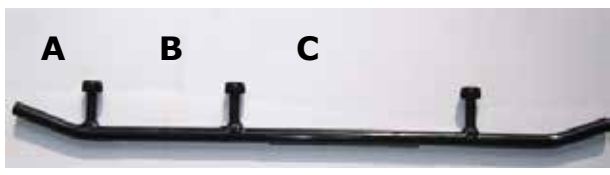
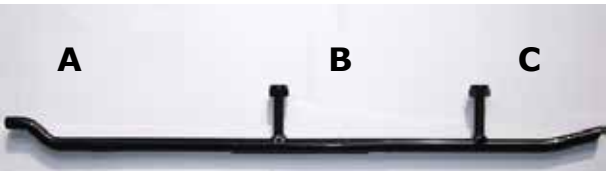
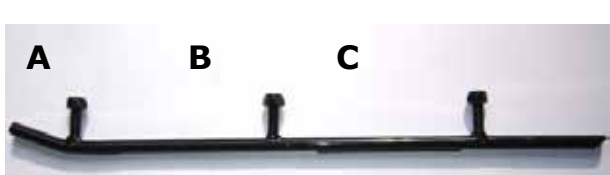
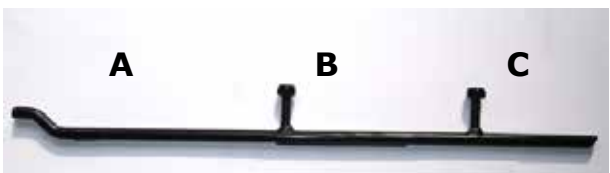
Normal	Racing	Carbide	L=longuer	A	B	C	D	E	
MM277		MM147	400	87	177	75	60		
			Ski de plastique, Camoplast ski 2003- Also for Skidoo and Polaris						
MM243	MM386	MM186	520	210	192	121			
			ADJ ski, CTRL ski 2003- The rear is bent for easier assembly of ski and plastic skis						
MM255			520		192				
			ADJ ski with three bolts						
SKI-DOO									
MM274		MM144	335	89	160				
			Pilotti ski/ Skidoo, narrow and wide						
MM277		MM147	400	87	177	75	60		
			Ski de plastique, Camoplast ski 2003- Also for Skidoo and Polaris Skandic 380-550 2003-						
MM279		MM146	534	84	103	190	103	54	
			Ski de plastique FLEX 1997- Also Lynx						
		MM141	445	54	95	222			
			Formula 583 1998 Formula III 600, 700 1997-99 Formula Mach I, Z 1997-99, Formula Z 1997-99 G-Touring 583, 670 1997-99, Summit 1997-99						
		MM142	502	90	126	110	116	60	
			MXZ 440, 583, 670 1996-99						

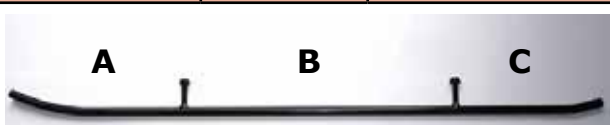





SKI-DOO



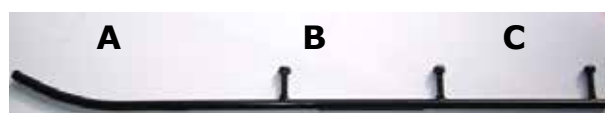
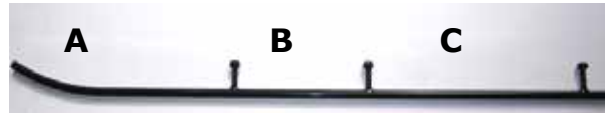

Lisse de ski

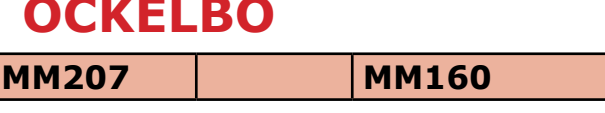
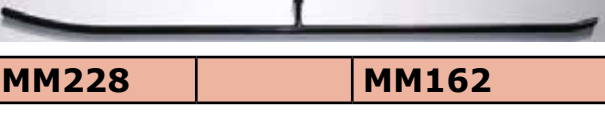
Normal	Racing	Carbide	L=longuer	A	B	C	D	E	
		MM143	495	54	120	196	115		
			Formula III 1985-96, Formula Mach Z 1985-96						
			Formula MXZ 1993-95, Formula Z 1994-96						
			G-Touring 583, 670 1993-96						
			Summit 1994-96						
MM229			602	248	176				
			Formula SP DL 1985-86, Tundra 1985-97						
			Safari 377, 447, 503 1984-88						
			Safari, Saga, Scout 1989-92						
			Skandic 377, 503 1986-87						
MM216		MM163	602		170	170	99		
			Formula Mach I 1989-94, Formula SS 1995-96						
			Formula MX, XTC 1985-95						
			Formula Plus, XTC 1985-93						
			Formula ST, STX 1994-96, Grand Touring 470 -95						
Safari DL, 503 Rally 1993-94, Safari GLX, LCE, L 1990-94, Skandic II 377, 503 92-94									
MM275		MM145	545		178	114			
			Blizzard 1978-84, Nordik 1981-83						
			Everest 1974-83, Olympique 1976-79						
			Skandic 277, 377 1982-85						
			TNT 1973-78						
MM215		MM176	527	238	177	112			
			Safari Cheyenne 1989-91						
			Alpine II 1991-95						
MM211		MM174	483	162	178				
			Citation 1980-91						
			Elan 1971						
MM250		MM193	625	321	241	63			
			Formula 500, DL 1996-99						
			Formula 583 1996-99, Formula S, SL, SLS 95-99						
			G-Touring 500 1996, Scandic 380, 500 1995-						
TRAPPER, NORDIK									
MM215		MM176	527	238	177	112			
			Nordik 300-377						
			Nordik 500-600						
			Nordik 540-600 SL						
MM227		MM171	480	250	148	82			
			Nordik 500 PSS,						
			Nordik 550						

POLARIS

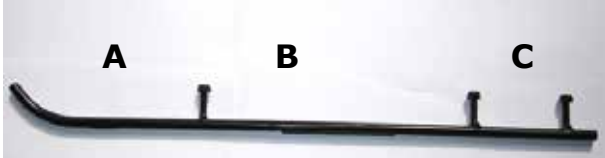
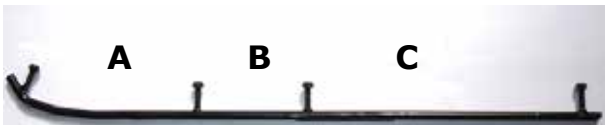
Lisse de ski

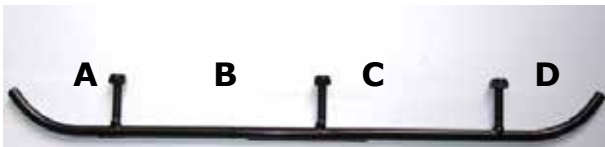
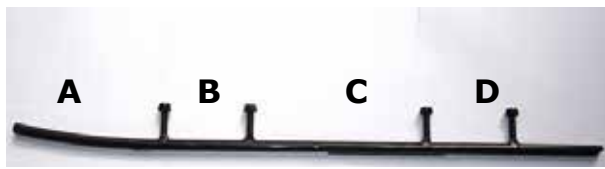
Normal	Racing	Carbide	L=longuer	A	B	C	D	E	
MM202	MM348	MM148	722	180	160	178	178		
			Ski de plastique 2007- Replaces original MM348 racing runner						
MM270		MM149	680	310	178	178			
			Ski de plastique 1997- Indy RMK 700, Indy XC 400, Indy XCR 600 1997- Indy Storm, Indy Ultra 1997-						
MM206		MM159	673	317	178	178			
			All mod. 1988-98 All with steel skis 1998-99 Indy Sport 1987						
MM209		MM177	813	317	178	255			
			Indy 400, 600, Trail, Longtrack, Sprint SS, Star, Startrack 1986-87						
MM208			813	405	408				
			All makes 1971-82 Indy 600, 400, Trail, Longtrack, Sport, SS, Star, LT 1983-85						
	MM398								
			Polaris Gripper ski						
<h3>OCKELBO</h3>									
MM207		MM160	800	395	405				
			All mod. -1986 Ockelbo						
MM228		MM162	450		270				
			All mod. 1987- Ockelbo						
<h3>YAMAHA</h3>									
MM219			578	57	184	311			
			BR 250 1982-94 ET 250, 300, 340 1977-84 SR 540 1980-84 SRX 440 1976-80						

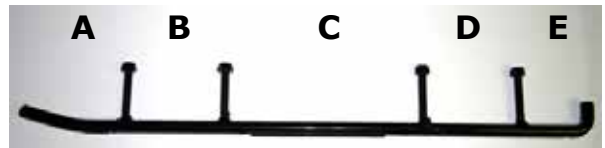
Normal	Racing	Carbide	L=longuer	A	B	C	D	E	
MM217		MM138	621	60	174	268			
			ET 340 1985-88						
MM224		MM164	635	216	292	101			
			Exiter 570 1987-90						
			SR 540, V-MAX 540 1987-91						
MM280		MM137	768		140	360			
			BR 250 T, TS 1984-98						
			ET 340 T, TR 1981-88						
			ET 400 T, TR 1989-91						
			EX 340, 440 1977-81						
MM232		MM166	663	57	183	210	101		
			CS 340 1990-99, Exiter II 570, SX 1991-93						
			Phazer II, E, ST 1984-99, SR 540 1985-86						
			V-Max 540 1983-86, Viking II 540 1988-92						
			XLV 540 1985-91						
MM235		MM175	604		181	210			
			ET 410 TR 1992-99						
			Viking II 540 E 1993-99						
			Venture 480 1991-99						
MM251		MM194	608	159	90	185	90		
			V-Max-4 1992-94						
			Venture 500,600,700 1995-96						
			V-Max 500, 600, 700 1994-96						
			V-Max 800 1995-97						
MM281		MM136	419		82	176	59	62	
			V-max 500, 600, 700 1997-99						
			Venture 500,600,700 1997-99						
MM282		MM135	475		124	160	118		
			SRX 600, 700 1998-						
MM239	MM339	MM139	530	100	90	180	90	70	
			RX, RX-1 2002-						

Poulie menée

année Year	modèle, make, modelle	Ro- tax	osa # part #	dia arbre
	Terri 30, 2020		14-6038	22,2
	Trapper, Ockelbo		14-6024	25,0
84-93	535, 5900 GLX, 650	503	14-6028	22,2
-93	GL 250	253	14-6028	22,2
-93	360, Ranger, GL3300	377	14-6028	22,2
94-96	360 S, Ranger	377	14-6041	22,2
-96	Ranger380,Fox,Light	380	N/A	
94-96	GLX 5900FC, 650 S	503	14-6041	22,2
94-96	GLX 5900 LC	493	14-6041	22,2
97-98	Ranger 380,	380	N/A	
97-98	Fox, S, Light Touring	380	N/A	
97-98	GLX 5900 FC, 6900	503	14-6032	25,0
97-98	GLX 5900 LC	493	14-6032	25,0
99-03	GLX 5900 FC	503	14-6032	25,0
99-04	6900	503	14-6032	25,0
99-??	Fox 440	447	N/A	
99-00	GLX 5900	493	14-6032	25,0
2000-	Ranger 500 FC	503	14-6032	25,0
2000-	Ranger 500 LC	493	14-6032	25,0
2001-	5900 ST	593	14-6032	25,0
2004-	SUV 550, Ranger	550	14-6032	25,0
2004-	6900	550	14-6032	25,0
2004-	SUV 600, ST 600	593	14-6033	25,0
2004-	5900 Yeti V-1000		14-6021	25,0
2005-	5900Yeti 600HO SDI	593	14-6021	25,0
2006-	SUV 600,Ranger 600	593	14-6021	25,0
2007-	TUV 600 HO SDI	593	14-6021	25,0
2007-	Yeti, Yeti Pro V-800	800	14-6021	25,0

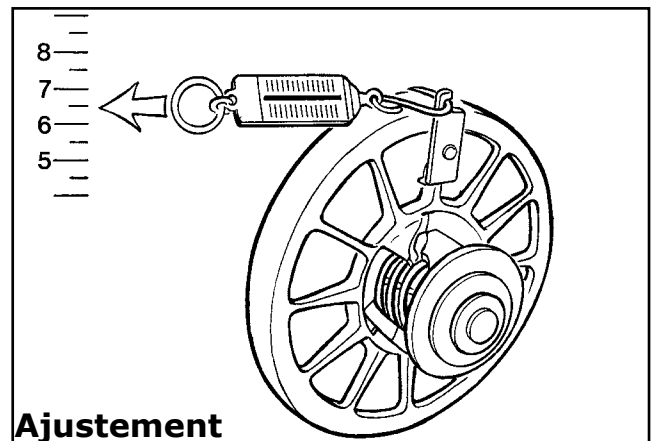

Ajustement
Lors de la réparation de votre poulie ou la pose d'une nouvelle poulie vous devez toujours vérifier le ressort de rappel de la poulie menée. Très souvent le ressort de rappel se ramolli et ne fait plus son travail. Si le ressort est trop mou l'embrayage s'effectuera trop tôt et empêchera le moteur de performer correctement Nettoyez correctement toutes les pièces, Resserrer ou remplacer le ressort de rappel. N'appliquez aucune graisse.

Alignement

Vérifiez l'alignement avec une règle de métal de 12 mm. s'il n'y a pas de caoutchouc d'arrêt pour empêcher le moteur de bouger la dimension **Y** doit être 1,0-1,5 mm plus grande que **X**. Aussi étant donné le diamètre plus petit de la poulie menante veuillez ne pas considérer la dimension **Z**.

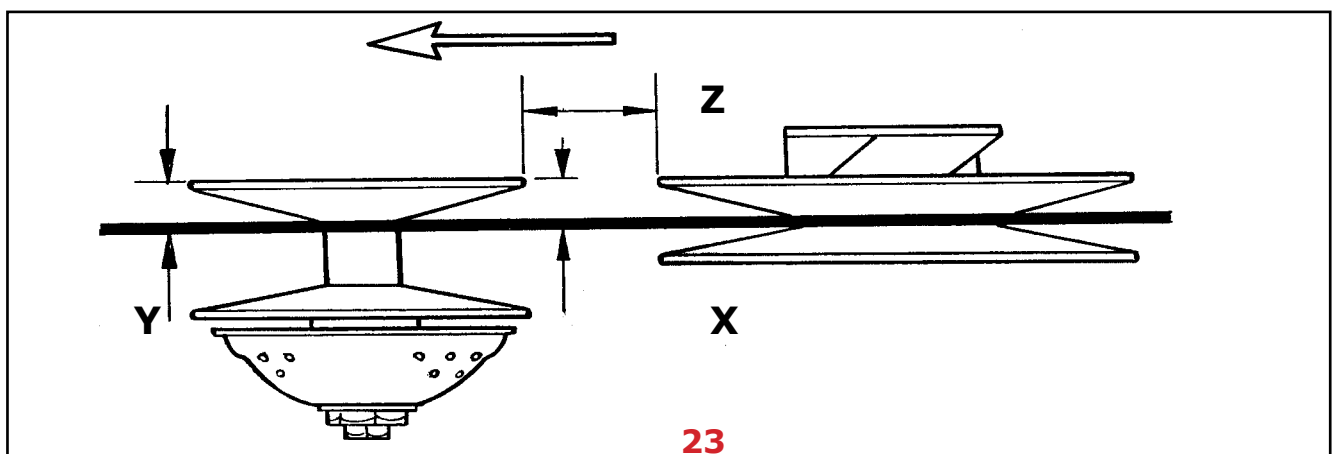

Powerbloc 80

Maintenance-free clutch now for powerfull liquid cooled engines This clutch does not have sleeves, levers or other parts that could be damaged. Very reliable. On the clutch can be installed the original starter ring. Clutch is supplied pre-calibrated



Poulie motrice a été en vente dans le début de 2008



Vous pouvez trouver toutes les calibrations sur notre page Web à:
[www.teolehtimaki.fi/spare parts catalogue](http://www.teolehtimaki.fi/spare_parts_catalogue)

Polaris

15-84	Tous les moteurs 488 cc	1989-
15-84	600 cc 2-cyl small cône	1997-
15-88	600 cc 2-cyl big cône	2007-
15-84	600 cc 3-cyl	1996
15-84	700 cc 2-cyl	1997-06
15-84	800 cc 2-cyl	2000-05
15-84	750 cc 4-temps turbo	2006-
18-88	800 cc, big 32 mm cône	2008-



Arctic Cat

Petit cône		
15-85	Tous les moteurs de moins de 700 cc	
Grand cône sur les moteurs suivants à partir de 2003		
15-86	599 3D 2-cyl. 114 hp 31 mm	2003-
15-86	658 cdi 3-cyl. 110 hp 4-temps, 31 mm	2003-
15-86	698 3D 2-cyl. 140 hp 31 mm	2003-

Skidoo & Lynx

15-81	Rotax 453	MXZ 440 LC X	
15-82	Rotax 593, 500SS	1999-2005	15-81 2006-
15-81	Rotax 693 2-cyl	1999-	
15-81	Rotax 699 3-cyl	1996-	
15-81	Rotax V-810	2007-	
15-81	Rotax V-1000	2003-	
15-81	Rotax V-1200	2009-	
15-82	Rotax 493, 494	1996-	
15-82	Rotax 593HO,600 SDI	2003-2005	15-81 2006-
15-81	Rotax 600 ACE, E-Tec	2009-	TRA fixing bolt
15-82	Rotax 670	1993-	
15-84	Rotax 582, 583, 643	1993-	no electric gear ring
15-82	Rotax 800HO, 800R	tout	
15-82	Rotax 800 E-Tec	N/A	N/A

Poulie motrice 15-81 et 15-82, grand cône. Sans couronne deux poulies peuvent être utilisés. Mais 15-84, petit cône.

Yamaha

15-83	500, 494 cc	1994-2001
15-83	600 cc 2-cyl	1994-1999
15-83	600 cc 3-cyl	1999-2002
15-83	700 cc	1996-2002
4-temps,		
15-83	499 cc 80 hp	2007-
15-83	973 cc 120 hp	
15-83	998 cc Rx 1	2003
15-83	1049 cc	2008-



P80 ressort

Numero		N min/ 72 mm	N max / 45 mm	Longueur	A dia.
15-91	0451-1135	900	1300	138,0	5,50
15-92	0451-1136	900	1600	109,0	6,00
15-93	0451-1132	810	1150	143,0	5,50
15-94	0451-1134	742	1612	95,0	6,00
15-95	0451-1109	300	1100	82,0	6,00
15-96	0451-1114	400	900	95,0	5,50
15-97	0451-1133	800	1300	121,0	5,50
15-98	0451-1113	400	700	111,0	4,90
15-99	0451-1128	700	900	176,0	4,75



**Extracteur pour poulies
P50, P80, TRA
Référence: 18-212**



P50 motrice Le numéro de la pièce est en bleu

Vous pouvez trouver toutes les calibrations sur notre page Web à:

www.teolehtimaki.fi/spare_parts_catalogue

Ces pages sont fréquemment mises à jour.

Number	S4B	P50 numero	CVTech	PTO	Belt	x	Use
15-02	5913B	0403-0002		2,50	31,7		15-02
15-03		0403-0003	15-0147C	8,77	34,8	8	15-03
15-04		0403-0004	15-0148C	8,77	34,8	8	15-04
15-05	0513B	0403-0005		11,5	33,3	6	15-05
15-06	8113B	0403-0006	15-0149C	6	34,9		15-06
15-09	9513B	0403-0009		11,5	34,9	6	15-04
15-10	9713B	0403-0010		5	33,3		15-10
15-11	9213B	0403-0011	15-0151C	1,5	34,9		15-11
15-18	9113B	0403-0018	Flasque	4,99	34,9		15-18
15-22	3113B	0403-0022	Flasque	0,06	32,7		15-22

S4B motrice n'est plus disponible X = Vis pour couronne, 6 mm or 8 mm

P50 ressort

Numero	CVTech	N min / 72 mm	N max / 45 mm	Longueur mm	A dia. mm	Note
15-52	0151-0002	618 / 637	1050 / 1115	110 / 108	5,26 / 5,50	+ 1
15-51	0151-0003	730 / 730	987 / 1056	158 / 132	4,88 / 5,50	+ 1
15-55	0151-0004	728 / 708	1110 / 1056	134 / 127	5,26 / 5,50	
15-53	0151-0006	500 / 499	1070 / 1142	095 / 93	5,71 / 6,00	
15-54	0451-1118	500 / 501	700 / 832	148 / 114	4,50 / 5,50	+ 1
15-55	0451-1129	700 / 708	1100 / 1056	123 / 127	5,26 / 5,50	
15-56	0451-1137	595 / 604	852 / 929	135 / 122	4,88 / 5,50	+ 1

Lorsque le moteur roule à pleine puissance, la capacité du ressort est plus élevée sur le **ressort bleu** que sur le ressort de CVTech. La calibration peut être ajustée en ajoutant une cale dans chaque bloc. N'oubliez pas qu'une cale équivaut à 100 RPM. Si l'engagement du régime moteur diffère du régime nominal, toujours vérifier l'ajustement du ressort et l'alignement de la ligne électrique.

**Extracteur pour poulies
P50, P80, TRA ; M14x1,5
Part number: 18-212**



**Wrench to open
P50, P80, ATV-clutch
Part number: 18-300**



ALT-Poulie motrice



15-0513A

15-3913A

15-3113A

15-2913A

Clutch	PTO type	PTO mm	Belt mm	Fits
15-0513A	Cone 30 mm 1/10	- 2,0	33,3	Lynx, Skidoo
15-0613A	Threaded 7/8" 14UNF		33,3	Alpine
15-0913A	Threaded 7/8" 14UNF		31,7	Alpine
15-1013A	Threaded 3/4" 14UNF		31,7	Elan
15-1213A	Cone 30 mm 1/10	- 6,35	31,7	Lynx, Skidoo
15-1713A	Trhrea M28x1" Cyl 24,6		31,7	Yamaha
15-2813A	Cone 30 mm 1/10	+14,27	34,9	Polaris
15-2913A	Cone 30 mm 1/10	- 12,7	31,7	Yamaha
15-3113A	Cone 30 mm 1/10	- 12,7	31,7	Yamaha
15-3913A	Cone 30 mm 1/10	- 12,7	33,3	Rotax 253
15-5013A	Cyl 1" ja key way 1/4"		31,7	

Spareparts for ALT models



16-11



16-06



16-09



16-08



18-060
18-090



16-07



16-02

ALT ressort

P/N	CVTech	length mm	Dia	min. Nm	max. Nm	i
19-12	X-5243212	70		108	1677	Terri
19-02	X-5243300	76,8	6,30	455	1852	6,00
19-01	X-5243302	78,5	6,30	526	1879	6,25
19-03	X-5243304	83		677	2050	
19-04	X-5243306	86		833	2070	
19-05	X-5243308	89		922	2090	
16-20	X-5218300	76,0	5,50	223	978	6,00
16-21	X-5218400	100,0	5,50	832	1535	6,25



**Extracteur pour poulies Alt
thread: 9/16 -18
Référence: 18-209**



S4B -Poulie motrice



18-130



18-030

S4B pièces de rechange



18-100



17-050



17-051



**18-060
18-090**



**18-140
18-200**



18-120



17-090



16-07



16-08



17-040 Capuchon

Poulie menée



**14-16
glissiere
de came**



**14-10
rondelle de
butée**



**Longueur 39 mm
Dia 1. 38 mm
Dia 2. 44,5 mm
14-08
coussinet**



**14-15
came 14- modeles**

P50 pièces de rechange



19-100



19-120



**19-170
19-171
19-140
17-112
18-160**

**vis hex.
polaris
rondelle
écrou
rondelle**



19-050



19-130



19-030



16-08



16-07

Trailbloc-ATV

Embrayage étalonné pour VTT,
fabricant

CVTech-IBC



cc	Polaris modèle	annee	étalonné	body
350	350L, Trail Boss 350	90-93	13-0042	23-0006
400	400L, Big Boss 6x6, Scrambler	94-02	13-0042	23-0006
	Sport 400L 2x4, Sportsman 400	94-05		
	Trail Blazer, Xplorer, Xpress	96-03		
425	Magnum 425 tous	95-98	13-0043	23-0006
455	Sportsman 450	06-07	13-0042	23-0006
499	ATP 500 HO 4x4,	04-05	13-0012	23-0002
	Sportsman EFI EBS tous	06-09		
	Sportsman 500 HO EBS, 500 DUSE	01-05		
	Sportsman 500 EN, Worker EBS	98-00		
499	Scrambler 500 tous	98-09	13-0040	23-0006
	Sportsman 500 HO, EFI	01-08		
499	Big Boss 6x6	98-02	13-0043	23-0006
	Magnum 500 4x4	2000		
	Scrambler 500 4x4, Xplorer 500	1997		
	Sportsman 500, 500 6x6	96-08		
600	Sportsman 600 Twin	03-05	13-0009	23-0001
700	Sportsman 700 Twin EBS	03-04	13-0009	23-0001
700	Sportsman MV7 EBS	2005	13-0010	23-0001
	Sportsman 700 EFI EBS	04-08		
800	Sportsman 800 EFI EBS	05-07	13-0011	23-0001
800	Sportsman 800 EFI	2007	13-0047	23-0005
697	Suzuki Twin Peaks 700 4x4	04-05	13-0007	23-0003
633	Arctic Cat 650 V-Twin 4x4 automatic	02-06	13-0007	23-0003
	Canam			
400	Outlander 400 HO	02-09	12-0066	23-0009
500	Outlander 500 HO, Renegade	07-10	12-0033	23-0011
650	Outlander 650 HO all	06-10	12-0034	23-0011
800	Outlander 800 HO, 800 R	06-11	12-0067	23-0010
800	Renegade 800 HO, 800 R	07-11	12-0068	23-0010
1000	Commander 1000	11-12	12-0075	23-0013
1000	Outlander/Renegade 1000	2012	12-0085	23-0010
	Honda Pilot	all	ALT motrice	
300	Kawasaki Prairie 300	99-02	P50 motrice	
400	Prairie 400	97-02	P50 motrice	
633	Brute Force 4x4 tous	05-10	13-0007	23-0003
697	Prairie 700 4x4 tous	04-06	13-0007	23-0003
749	Brute Force 750 4x4 tous	05-07	13-0007	23-0003

11 maillons	longueur	13 maillons	length	15 maillons	longueur
45-064	64	46-064	64	50-064	64
45-066	66	46-066	66	50-066	66
45-068	68	46-068	68	50-068	68
45-070	70	46-070	70	50-070	70
45-072	72	46-072	72	50-072	72
45-074	74	46-074	74	50-074	74
45-090	90	46-076	76	50-076	76
		46-102	102	50-078	78
Silent chaîne		46-104	104		
		46-106	106		
		46-108	108		

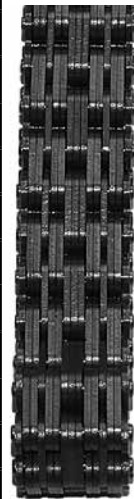

3/4" Hyvo chaîne

7/8" Hyvo chaîne

3/4" maillons	longueur	3/4" maillons	length	7/8" maillons	longueur
52-66	66	52-80	80	53-70	70
52-68	68	52-82	82	53-72	72
52-70	70	52-86	86	53-74	74
52-72	72	52-90	90	53-76	76
52-74	74	52-92	92	53-78	78
52-76	76	52-94	94	Original	
52-78	78	Borg Warner originale de la chaîne			

Pignons, Skidoo, Lynx

11 wide	Z	13 wide	Z	15 wide	Z	Low 13	Z	Low 15	Z
45-016	16	46-016	16						
45-017	17	46-017	17			55-43	43	58-43	43
45-018	18	46-018	18			55-44	44		
45-019	19	46-019	19	50-019	19	55-45	45	58-45	45
45-020	20	46-020	20	50-020	20				
45-021	21	46-021	21	50-021	21				
45-022	22	46-022	22	50-022	22				
45-023	23	46-023	23	50-023	23				
45-024	24	46-024	24	50-024	24				
		46-025	25	50-025	25				
		46-026	26						

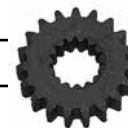

Pignons, 7/8"-13 spline

Arctic Cat all, not Diamond drive, Polaris up to 1996

11-wide	Z	11-wide	Z	13-wide	Z	13-wide	Z
47-016	16	47-021	21	48-016	16	48-021	21
47-017	17	47-022	22	48-017	17	48-022	22
47-018	18	47-023	23	48-018	18	48-023	23
47-019	19	47-024	24	48-019	19	48-024	24
47-020	20			48-020	20		

Arctic Cat vilebrequin, roulement à billes

Crank	2-CYL F/C	Years	MGT	CENTER	PTO
3003275	340 F/C inj	87-94	83350A (DG2555	83350A (DG2555)	83519D x 83519D
3006941	370 F/C	99-08	83519D	83519D x 83519D	83519D x 83519D
3005921	440 F/C	97-06	83519D	83519D x 83519D	83519D x 83519D
3006098	440 F/C	02-06	83519D	83519D x 83519D	OE 3006-096 x 2
3003401	500 F/C	Kaikki	83519D x 83519D	83519D x 83519D	83519D x 83519D
3006005	570 F/C	02-09	6306N9C4 /	6306N9C4 x 2	35NQ5528W11
3007864	570 F/C	10-14	6306N9C4	6306N9C4 x 2	35NQ5528W11
	2-CYL L/C				
3004461	440 L/C	91-99	83519D	83519D x 83519D	OEM N/A
3003213	440 L/C	85-89	83519D x 83519D	83A073B x 83A073B	83A0729 x 2
3003832	440 L/C ZR	91-95	6306N9C4	83A073B x 83A073B	40NQ 6430W1
3005258	440 L/C ZR	96-98	6306N9C4	83A073B x 83A073B	40NQ 6430W1
3006624	440L/C	03-04	306/1DYR1W	83B551A 30mm x 2	40NQ 6430W1S
3006428	F-5	03-06	306/1DYR1W	83B551A 30mm x 2	40NQ 6430W1S
3007613	F-5	06-09	306/1DYR1W	83B551A 30mm x 2	40NQ 6430W1S
3005414	5-600ZR T-	98-03	83A073-9	83A073B x 83A073B	40NQ 6430W1
3003841	530 L/C	86-87	83519D	83A073B x 83A073B	OEM N/A
3003931	550 L/C	90-92	83A073-9	83A073A x 83A073B	40NQ 6430W1
3005230	550-580 L/C	93-05	83A073-9	83A073A x 83A073B	40NQ 6430W1
3005602	600 ZR	00-04	6306/4DYR1	83B551A 30mm x 2	40NQ 6430W1
	600 Sno Pro	04-	22075/1DYR1W	83B551A 35mm x 2	40NQ 6430W1S
3003894	650 L/C W-C	88-90	83B551A 35mm	83B551A 35mm x 2	OEM N/A
3004144	700 L/C EFI	93	83B551A 35mm	83B551A 35mm x 2	40NQ 6430W1
3004391	700 L/C	94-01	83B551A 35mm	83B551A 35mm x 2	40NQ 6430W1
3006710	F6-F7	03-06	22075/1DYR1W	83B551A 35mm x 2	40NQ 6430W1S
3006718	600-700 L/C	03-10	22075/1DYR1W	83B551A 35mm x 2	40NQ 6430W1S
3006053	800-900	02-08	307/1DYR1W10	6307R/1DYR x 2	3208/1DW11CA
	800 L/C	07-12	22075/1DYR1W	83B551A 35mm x 2	40NQ 6430W1S
3006918	900 L/C	03-05	307/1DYR1W10	6307R/1DYR x 2	3208/1DW11CA
3007260	1000 L/C	07-11	308YR1W10C =	DG379021NSL x 2 =	3209W11C4 =
	3-CYL L/C		37 x 90 x 23	37 x 90 x 21	45 x 85 x 30,2
	600 L/C ZRT	95-02	83A073B	6207R9x2, 83A073Bx2	40NQ 6430W1
3004929	800-900 L/C	93-00	6306/4DYRI	6209/1DRIN X 4	6209/1DRIN X 2
3005640	1000 L/C	98-02	6306/4DYRI	6209/1DRIN X 4	6209/1DRIN X 2

Part number	Dimensions		Part number	Dimensions	
	22075/1DYR1W	35 X 75 X 23		DG2555	25 X 55 X 15
	3208/1DW11CA	40 X 83 X 30		35NQ5528W11	35 X 55 X 28
	306/1DYR1W	30 X 75 X 19		40NQ6430WI	40 X 64 X 30
	307/1DYR1W10	35 X 83 X 21		40NQ6430W1S	40 X 64 X 30
	6209/1DRIN	45 X 90 X 19		83519D	30 X 65 X 16
	6207R9	35 X 72 X 17		83A073-9	30 X 72 X 19
	6306/4DYR1	30 X 72 X 19		83350A	25 X 55 X 15
	6306/N9C4	30 X 72 X 19		83B551A 30 mm	30 X 75 X 17
	6307R/1DYR	35 X 83 X 21		31 83B551A 35 mm	35 X 75 X 17

Rotax = Skidoo, Lynx

Vilebrequin, roulement à billes

Crank	1-CYL F/C		MGT	CENTER	PTO
4210001	247 F/C ELAN	85-96	83464C (6305C4)		83464C (6305C4)
4210002	253 F/C	85-92	6206 GPC4 (NR)		6206 GPC4
4210031	277 F/C	93-05	6206 C4		6306 PC4
4210639	277 F/C	06-09	6206 C4		6306 PC4
	2-CYL F/C				
4210028	377-447 Nippon D	82-89	6207 GPC4	6305 NRC4 x 2	6206 GPC4 x 2
4210009	377-447 F/C	90-96	6207 GPC4	6207 GPC4 x 2	6207 PC4 x 2
4210154	377-447	97-07	6207 GPC4	6207 GPC4 x 2	6207 PC4 x 2
4210033	503 Kärjet	79-81	6207 GPC4	6305-NRC4 x 2	6206 GPC4 x 2
4210032	503 Nippon D	82-89	6207 GPC4	6305 NRC4x6206 GPC4	6206 GPC4 x 2
4210011	503 F/C	90-96	6207 GPC4	6207 GPC4 x 2	6207 GPC4 x 2
4210155	503 F/C	97-03	6207 PC4	6207 PC4 x 2	6207 PC4 x 6207 GPC4
4210601	550 Top needle	03-09	6207 GPC4	6207 PC4 x 6207 PC4	6207 GPC4x6207GSPC4
4210673	550 F/C	10-14	6207 GPC4	6207 GPC4 x 6207 PC4	6207 GPC4x6207GSPC4
	2-CYL L/C				
4210567	440 MXZ-X, 500	00-05	6206 PC4 x 2	6206 PC4 x 2	6207 PC4 x 2
4210016	444 L/C	75-80	6206 GPC4	6305 NRC4 x 2	6206 GPC4 x 2
4210150	454 L/C	95-98	6206 PC4 x 2	6206 PC4 x 2	6207 PC4 x 2
4210017	462 L/C SP-SS	84-86	6206 GPC4	6305 NRC4x6206 GPC4	6206 GPC4 x 2
4210019	467 L/C	85-95	6206 GPC4 x 2	6305 NRC4x6206 GPC4	6207 GPC4x 2
4210151	494 L/C T-Crank	96-00	6206 PC4 x 2	6206 PC4 x 2	6207 PC4 x 2
4210599	500 L/C	03	6206 PC4x804551	6206 PC4 x 2	FAG x 6207 PC4
4210021	532-536-582-583	85-99	6206 GPC4 x 2	6305 NRC4x6206 GPC4	6207 NRC4 x 2
4210553	600 L/C C-Seal 63	1999	6206 PC4 x 2	6206 GPC4 x 2	6207 PC4 x 2
4210563	600 L/C C-Seal 66	00-02	6207 PC4 x 2	6206 GPC4 x 2	804661BL178x6207PC4
4210611	500SS, 600 C-S 66	2003-	804551x6206 PC4	6206 PC4 x 2	804661BL178x6207PC4
4210576	600 MXZX RS	2008-	6207 PC4 x 2	6207 PC4 x 2	804662E x 6208 PC4
4210609	600 HO C-Seal 76	03-07	FAG x 6207PC4	6207 PC4 x 2	804661BL178x6207PC4
4210622	600/593 E-Tec	All	FAG x 6207PC4	6207 PC4 x 2	6208X x 804662E
4210023	617-643 L/C	91-92	6206 GPC4 x 2	6305 NRC4x6206 GPC4	6207 GPC4 x 2
4210046	670 L/C	95-99	6206 PC4 x 2	6206 PC4 x 2	6207 GPC4 x 2
4210570	700 L/C C-Seal 79	99-00	6207 PC4 x 2	6207 PC4 x 2	6208 PC4 X 2
4210569	700 L/C C-Seal 76	2000	6207 PC4 x 2	6207 PC4 x 2	6208 PC4 x 2
4210574	700 L/C Mgt seal	01-02	FAG x 6207PC4	6207 PC4 x 2	6208 PC4 x 2
4210609	700 L/C C-Seal 76	03-05	FAG x 6207PC4	6207 PC4 x 2	6208 PC4 x 804662E
4210573	800 L / C	00-02	FAG x 6207PC4	6207 PC4 x 2	6208 PC4 x 2
4210607	800 L/C HO	04-06	FAG x 6207PC4	6207 PC4 x 2	6208 PC4 X 2
4210606	800 L/C HO SDI	03-04	FAG x 6207PC4	6207 PC4 x 2	6208X x 804662E
4210608	800 L/C	2003	FAG x 6207PC4	6207 PC4 x 2	6208X x 804662E
4210665	800 L/C R PTEK	07-08	FAG x 6207PC4	6207 PC4 x 2	6208X x 804662E
4210668	800 L/C E TEK	09-14	FAG x 6207PC4	6207 GSPC4 x 2	6208X x 804662E
4210634	1000 L/ HO	05-07	804662E x 2	6208 PC4 x 2	804662E x 2
	3-CYL L/C				
4210152	600 L/C	96-97	6208-PC4	6206 PC4 x 4	6208 PC4 x 2
4210311	600-700 L/C CK3	98-00	6208-PC4	6206 PC4 x 4	6208 PC4 x 2
4210048	779 L/C	93-96	6208-PC4	6207 GPC4x 4	6208 PC4 x 2
4210157	809 L/C	99-03	6208-PC4	6207 PC4 x 4	6208 PC4 x 2

Part number
Dimensions**Rotax****Part number****Dimensions**

Part number 35-	Dimensions	Parts number 35-	Dimensions
6305 C4 = 83464 C	25 X 62 X 17	6207 C4	35 X 72 X 17
6305 NRC4	25 X 62 X 17	6207 PC4	35 X 72 X 17
6306 NRC4	30 X 72 X 19	6207 GPC4	35 X 72 X 17
6206 C4	30 X 62 X 16	804551 = 6206 GSPC4	30 X 62 X 18/19
6206 PC4	30 X 62 X 16	804662E = 6208 GSPC4	40 X 80 X 21
6206 GPC4	30 X 62 X 16	6208 PC4	40 X 80 X 18
FAG = 804661BL178	35 X 72 X 17/18	6208X = 6208X28YR1N	40 X 80 X 23
FAG = 6207 GSPC4	35 X 72 X 17/18	6208 GSPC4	40 X 80 X 21

Part number
Dimensions**Yamaha Vilebrequin, roulement à billes**

Crank	1-CYL F/C		MGT	CENTER	PTO
8R4114000	250 BRAVO	82-10	6305 H/INDY		6306 N9C4
	2-CYL F/C				
34X114000	300-340 F/C	77-99	83464-C	83548D-9	6306 N9C4
1GU114000	400-410 F/C	89-95	83464-C	83548D-9 x 83548D-9	OEM N/A
8K4114000	440 SS	80-84	83548D9	6206B/32C4 x 2	DG3278JSOx2
8VO114000	485 F/C	84-98	DG3268-B	DG3268-B x DG3268-B	83A779 x 2
8DU114000	500 F/C	99-02	DG3268B	DG3268-B x DG3268-B	83A779 x 2
8H8114000	535-540 F/C	79-06	83548D9	83548D-9 x 83548D-9	DG3278JSOx2
	2-CYL L/C				
82M114000	500-570-600cc	87-96	83B207	6207R9 x 6207R9	83A7269 x 2
82R114000	500-600 L/C	97-	83B207	6207R9 x 6207R9	6206B / 32C4
	3-CYL L/C				
8CH114000	700 L/C SX	97-06	62/32GPC4 x 2	62/32GPC4 x 2 x OEM	OEM N/A
	600-700 SX	98-06	OEM N/A	OEM N/A	OEM N/A
	600-700 SRX	98-99	OEM N/A	OEM N/A	OEM N/A
	600-700 SRX	00-02	OEM N/A	OEM N/A	OEM N/A
8EK114000	700 L/C VIPER	02-06	OEM N/A	OEM N/A	OEM N/A
	4-CYL L/C		LEFT	CENTRE-GEAR CENTRE	RIGHT
8AX11401	750 / 8AX-11401	92-94	6206PC4	6206PC4 x 4 x 6305GPC4	OEM N/A
8AX11402	750 / 8AX-11402	92-94	6206PC4	6206PC4 x 4 x 6305GPC4	83464C
8BU11401	800 / 8BU-11401	95-97	6206PC4	6206PC4 x 4 x 6305GPC4	OEM N/A
8BU11402	800 / 8BU-11402	95-97	6206PC4	6206PC4 x 4 x 6305GPC4	OEM N/A

Part number
Dimensions**Part number****Dimensions**

Part number 35-	Dimensions		Parts number 35-	Dimensions
6206 C4	30 X 62 X 16		83464C	25 X 62 X 17
6206 PC4	30 X 62 X 16		83A779	32 X 78 X 19
6305 H/INDY	25 X 68 X 17		83548D-9	32 X 62 X 16
6306 NRC4	30 X 75 X 19		83B207	32 X 72 X 30
6206 N9C4	30 X 72 X 19		DG3268-B	32 X 68 X 16
62/32 GPC4	32 X 65 X 17		DG3278JSO	32 X 78 X 16,5

Part number
Dimensions

Polaris Vilebrequin, roulement à billes

Crank	2-CYL F/C		MGT	CENTER X 2	PTO
3083577	340 F/C Injection	Kaikki	6206 C4	6007 PC4 x 2	6206 GPC4 x 6206 PC4
3084585	440-500 F/C	Kaikki	6206 PC4	6206 PC4 x 2	6206 GPC4 x 6206 PC4
3089483	440 XCF-550 F/C	98-13	5206 S9C4	6206 PC4 x 2	6207 GPC4 x 6207 PC4
	2-CYL L/C				
3084612	440-500L/C	86-95	6206 PC4	6206 PC4 x 2	6206 GPC4 x 6206 PC4
3084701	440 L/C XCR	94-95	6206 PC4	6206 PC4 x 2	6206 GPC4 x 6206 PC4
3085211	440 L/C XCR	96-97	6206 PC4	6206 PC4 x 2	62/32 PC4 x 62/32 GPC4
3085206	500 L/C	96-00	6206 PC4	6206 PC4 x 2	62/32 PC4 x 62/32 GPC4
3089530	500 L/C	00-10	5206 S9	6206 PC4 x 2	62/32 PC4 x 62/32 GPC4
2201865	440 L/C PRO X	98-03	6207 PC4	DG3572201C4	DG3572201C4 x 6207PC4
2202688	440 L/C PRO X	04-07	6207 PC4	DG3572201C4	DG3572201C4 x 6207PC4
2201234	500-600 L/C	98-03	6207 PC4	DG3572201C4	6207/9BA9T x 6207 PC4
2202520	500-600 L/C X	04-09	6207 PC4	DG3572201C4	6207/9BA9T x 6207 PC4
2201662	600-700 L/C	97-98	6207 PC4 x 2	6207 PC4 x 2	6207 GPC4 x 6207 9BA
2203320	600 HO, CF	07-13	6207 / 1BYA	DG3572201C4	6207/9BA9T x 2
2203803	600 IQ Racer	2008	6207 / 1BYA	DG3572201C4	6207/9BA9T, DG3572201C4
2203717	600 IQ Racer	09-14	6207 / 1BYA	DG3572201C4	6207 GPC4 X 5207SC4
2203578	600-700 LC IQ D	07-10	6207 / 1BYA	DG3572201C4	6207/9BA9T X 2
2201361	600-700 L/C HD	99-05	6207 PC4 x 2	6207 GPC4 x 2	5207 S9C4 x 6207 PC4
2203110	700 L/C Fusion	06	6207 / 1BYA	6207 GPC4 x 2	5208C4 x 2
2202443	700 L/C Front. 4-t	02-04			6207/9BA9T x 6207 GPC4
2201554	800 L/C Heavy	00-05	6207 PC4 x 2	6207 GPC4 x 2	5207 S9C4 x 6207 PC4
2203717	800 L/C Dragon,	08-13	6207 / 1BYA	DG3572201C4	5207 S9C4 x 6207 PC4
2203110	900 L/C	05-06	6207 / 1BYA	6207 GPC4 x 2	5208C4 x 2
	3- CYL L/C				
3084596	580 L/C mono	92-94	6206 PC4	6206 PC4 x 4	6206 GPC4 x 6206 PC4
3084679	600 L/C mono	95-96	5206 S9	6206 PC4 x 4	6206 GPC4 x 6206 PC4
3085437	600 L/C oil jet	97-00	5206 S9	6206 PC4 x 4	6206 GPC4 x 5206S9
3085250	600 SP-680 L/C	96	35BG06 S9	6007 PC4 x 4	6207 GPC4 x 6207 PC4
3084377	650 L/C CARB-	85-98	5206-S9	6206 PC4 x 4	6206 GPC4 x 5206S9
3085450	600-680-700	97-98	35BG06 S9	6007 PC4 x 4	6207 PC4 x 6207 GPC4
3085312	750-800 L/C	93-98	6207 PC4 x 2	6207 PC4 x 4	6307 GPC4 x 6307 PC4
3086127	700-800 XCR	99-03	35BG06 S9	6007 PC4 x 4	6207 GPC4 x 6207 PC4

Part number Dimensions

Part number 35-	Dimensions		5206 S9	30 X 62 X 23,8
6206 C4	30 X 62 X 16		5207 / 1BYA	35 X 72 X 36,5
6206 PC4	30 X 62 X 16		5207 S9C4	35 X 72 X 27
6206 GPC4	30 X 62 X 16		5208 C4	40 X 80 X 30,2
6207 PC4	35 X 72 X 17		62/32 GPC4	32 X 65 X 17
6207 GPC4	35 X 72 X 17		35BG06 S9	35 X 62 X 23,8
6207/9BA9T	35 X 72 X 24		DG3572201C4	35 X 78 X 20
6307 PC4	35 X 80 X 21		6307 GPC4	35 X 80 X 21

Part number Dimensions

Vilebrequins web, Rotax

09-187	Rotax 503	pin 24 mm
09-1880	Rotax 670	pin 24 mm
09-1881	Rotax 800HO	pin 27 mm
09-1882	Rotax 500 + 600	pin 24 mm
09-1883	Rotax 600 + 700	pin 27 mm
09-1884	Rotax 800R	pin 30 mm



Vilebrequins web, Polaris

09-241	Polaris XC500+XC600	pin 28 mm
09-185	Polaris XC800	pin 27 mm
09-186	Polaris XC700	pin 28 mm



Anneau d'étanchéité / driveshaft-Lynx gearbox

36-00	AS	25	52	07
36-01	AS	25	52	10
36-02	AS	26	52	07
36-04	AS	26	52	08
36-05	AS	20	40	07
36-06	AS	25	42	07

Vilebrequins scellés



09-501731 09-501372 09-501497 09-190 09-501622

09-501731	30 X 42 X 7 (09-113) Rotax
09-167	30X62X7/8 Rotax (no photo)
09-501372	35 X 72 X 7/8 (09-165) Rotax
09-501497	40 X 80 X 7 (09-170) Rotax
09-190	ATS DUO 34.6x76x2.6/10.2, centrum
09-501622	40 X 84 X 2,6 / 10,2 Rotax, centrum
09-501584	35 X 72/76 X 7/9 Polaris
09-501909	24 X 44 X 11,4 Polaris
09-501414	30 X 62 / 63,7 X 7 (14202) Polaris



09-501584 09-501909

Moteurs réusinés

Available with short delivery time.

Moteur réusiné comprend :

- Base de moteur ré-usiné
- Pistons neuf
- Vilebrequin ré-usiné
- Cylindre replaqué ou alésé
- Ensemble de joint neuf
- Roulement neuf
- 500 ml d'huile pour rodage
- Arbre de valve rotative

Note : Ces prix n'incluent pas l'échange du vieux noyau (core)

Vilebrequins réusinés:

- tous roulement à billes
- centrum Vilebrequins scellés
- Applications des bielles
- straight: 0-OEM specs
- 1 an de garantie = Sans fautes / aucune question

Vilebrequins réusinés



Arctic Cat Vilebrequins réusinés

2-cylindres F/C

63-570KA	570	02-09	Bearcat 570 / 570 XT ; F570 ; Z570	PTO bolt	35-503
#3006 005			Panther 570, Mountaincat 570	1/2" x 20 x 5 1/2	

2-cylindres L/C

63-440KD	440	96-98	ZR 440; ZR 440 Sno Pro		
#3005 258					
63-600KA	500-	98-03	Powder Special 500-600		
#3005 414	600		ZL/ZR 500-600; EFI; LE		
63-700KF	600-	03-10	CF600, CF700, Firecat 600/700		
#3306 718	700		M6-M7, Pantera 600, Sabercat 6-700		

Yamaha Vilebrequins réusinés

# pièces	cc	Année	Modèle	note	roul.aiguilles
2-cylindres F/C					
62-540KA	535	79-13	EC540, SR540, XL540		35-521
#8H8114000	540		Viking II ja III tous		
2-cylindres L/C					
62-570KA	570	87-96	EX 570, EX 570 SX		35-507
#82M114000	500, 600	L/C			
62-600KA	500-	97+	Venture 500/600, SX 600, SXR 500		35-507
#82R114000	600		Venture Lite 500, Mountain Max 600		
3-cylindres L/C					
62-700KA	700	02-06	SXV Viper / ER		35-507
#8EK114000			Huom: päätylaakerit erikseen, 300,-		

Rotax, Lynx & Skidoo Vilebrequins réusinés

# p/n	cc	année	modèle	specific	aiguilles
1-cylinder F/C motor					
60-247KA	247	85-96	Elan 250 & Elan 250 DLX	avec roul a bil	35-505
#4210001					
60-253KA	253	85-92	Citation, Safari, Tundra LT, Lynx 250		35-505
#4210002			Nordik 300, 300R		
60-277KA	277	93-05	#4210030; 420995301; Tundra II, LT, R		35-505
60-277KB	277	06-09	#4210639; 420889630; Scandik, Tundra 300		35-505
2-cylindres Free-Air motor					
60-340KA	340		RV 340		35-505
#4210013	76-77		#4210014; 1975		
2-cylindres F/C motor					
60-343KA	343	75-79	Everest RV/TNT, Olympique 340	arbre conique	35-505
#4210010			345, 346, 400	PTO	
60-440KB	440	75-79	Everest, Olympique TNT 440	arbre conique	35-505
#4210004				PTO	
60-377KA	377-	80-81	Citation 4500 & SS, Lynx makes	breaker	35-505
#4210029	477				
60-377KB	377-	82-89	Nordik 500, Safari 377, 447, Scout	Nippo	35-505
#4210028	447		Lynx, Trapper 500, Skandic 377		
60-377KC	377-	90-96	Formula S, Nordik 500, Nordik 377R		35-505
#4210009	447		Scandik 377/R, Touring, Lynx		
60-447KA	377-	97-07	Lynx, Formula S/DLX, GTour 380, MXZ 440		35-505
#4210154	447; 420889630;		GSX-GTX 380, Legend 380, Scandic 380/440/LT		
60-503KA	503	79-81	Blizzard 5500, Everest 500, Lynx	breaker	35-505
#4210033					
60-503KB	503	82-89	Alpine 503, Lynxit, Trapper 600		35-505
#4210032	#4210155		Scandic 503, Cheyenne, Safari 503		
60-503KC	503	90-96	Alpine II, Lynxit, Nordik 600		35-505
#4210011			Scandic WT, Scandic II, 503R, SLT		
60-503KD	503	97-03	Lynx, Formula S, Legend, MXZ 500		35-505
420996445	420888390/1		Scandic SWT, WT, Touring E, LT, SLE		
60-550KA	550	03-09	Scandic 550, SUV, WT, SWT, MXZ	graisse	35-524
#4210601	420 889 062		Freestyle, GSX-GTX, Summit 550	needlecage	
60-550KB	550	10-12	Scandic, Tundra SUV 550, MXZ, TNT	graisse	35-507
#4210673	420 889 067		Renegade, GT 550,	needlecage	
3-cylindres; L/C motor					
60-600KF	700	98-00	Formula III 600 / 700 / 700R	CK3	35-503
#4210311	420888030		Mach I & I R, GT 700 SE / SE ME		
60-600KG		96-97	Formula III 600 / 600LT / 700R		35-503
#4210152			Mach I & I R		
60-809KA	809	97-03	Formula III 800, GT SE ME / 800 SE		35-505
#4210157	420887667		Mach Z (LT, LTR, M.H.R., R)		

Rotax, Lynx & Skidoo Vilebrequins réusinés

L/C; Liquid cooled

# pièces	cc	année	modèle	specific	aiguilles
2-cylindres; L/C motor					
60-440KB	440-	00-05	MXZ X 440, 440 Racing	graisse	35-503
421000567	500; 420885462; Formula DLX, MXZ 500, Legend 500				
60-500KA	494	96-00	Scandic 500 WT, Lynx, MXZ 500	needlecage	35-503
421000151	420886933		Formula Z 500, Summit 500, GT 500		
60-582KA	582	83-99	Lynxit, Formula STX, DLX, Z583,		35-505
421000021	Plus, Plus X, LT, XTC, Mach I, Summit				
60-600KA	500ss	03-12	Lynx WT, SUV, Scandic 600, MXZ 600	graisse, 66 mm	35-507
421000611	420888757		MXZ SS, GTX SS, all SS engines	joint du centre	
60-600KB	600	1999	MXZ & Summit 600	grease, 62 mm	35-507
421000553	420888250			joint du centre	
60-600KC	600	00-02	Formula DX, Z600, Scandic 600	graisse, 62 mm	35-507
421000563	420888252/1		MXZ, Legend 600, Summit 600	joint du centre	
60-600KD	600ho	03-07	Summit 600HO, Renegade 600HO/X		35-507
421000609	420889091		MXZ 600, Rev 600HO		
60-600KR	600rs	08-10	MXZ MXZ X 600 RS	graisse	35-507
421000576					
60-600KE	600	04-12	420890950/1, All SDI engines	graisse	35-507
421000622	4210664, 420890956/5/4;		All ETek engines	clé 12 o'clock	
60-670KB	670	95-99	Formula SS, Z670, MXZ 670	clé 06 o'clock	35-507
421000046			Mach 1, Summit 670, Lynx	needlecage	
60-700KA	700	99-00	MXZ 700, Summit 700	graisse, 79 mm	35-507
421000570				centrum seal	
60-700KB	700	2000	MXZ 700, Formula 700 DLX, Z700	graisse, 76 mm	35-507
421000569			Summit 700 SB, HM, Lynx	joint du centre	
60-700KC	700	01-02	Formula DLX, Legend 700	graisse, 76 mm	35-507
421000574	420888266		GT 700, MXZ, Summit 700, Lynx	joint du centre	
60-600KD	700	03-07	GT 700, MXZ, Summit 700,	graisse, 76 mm	35-507
421000609	420889091		Legend 700, Lynx	joint du centre, 2x PTO shim	
60-800KA	800	00-02	GT 800, Legend 800, MXZ 800	graisse, 76 mm	35-507
4210573	420888402		Summit 800, HM, Lynx	joint du centre	
60-800KC	800	04-07	GSX-GTX 800HO, MXZ 800HO	graisse, 76 mm	35-507
421000607	420889671		Renegade 800/X, Summit 800/X	centrum seal, 1 x shim, 1 x sg	
60-800KB	800	03-04	SDI, Grand Touring 800 SDI	graisse, 76 mm	35-507
421000606	420889106		Legend 800 SDI	centrum seal, key 12 o'clock	
60-800KR	800R	06-08	All 800 R engines	graisse, shim	35-415R
421000665	420892562			centrum seal, clé 02 o'clock	
60-800KP	800	09-12	All PTEK engines	graisse, shim	35-415R
421000668	420892567		420893090; 420893093; 420893098	seeger, clé 12 o'clock	
60-1000KA	1000	05-07	All 1000 SDI engines	graisse 100 g.	
421000634	420889217				

Polaris Vilebrequins réusinés

# p/n	cc	année	modèle	specific.	roul.aiguilles
2-cylindres F/C motor					
61-340KA	340	tous	Sport, GT Sport, SS, Star,		35-522
#3083577			Trail SKS,		
61-550KA	440-	02-11	440 XCF, all 550 makes		35-503
#3089483	500				
2-cylindres L/C					
61-440KA	440	98-03	440 Pro X	6 dents	35-503
#2201865					
61-500KA	440-	tous	Sport, SKS, Touring		35-503
#3084585	500		Super Sport, Transport, XCF		
61-500K	440-	86-95	440 L/C, Widetrack LX	PTO seal 30	35-503
#3084612	500		500 SKS, Carb, EFI, Classic, Touring	square key	
61-500KB	500	96-00	440 L/C Indy, 500 RMK, SKS, Classic	seal Pto 32	35-503
#3085206	CARB	EFI	Classic Touring	square key, Fuji	
61-500KC	500	00-11	Wide Track, 500 Classic/Indy	seal Pto 32	35-503
#3089530				moon key, big bearing MGT	
61-500KD	500-	98-03	440 XCR, XC, SP, 500 XC, SP, RMK	6 dents	35-507
#2201234	600		600 Touring, XC, SP, PPro X, RMK		
61-600KK	600-	97-98	RMK, SKS, XC	centre solide	35-507
#1201663	700				
61-600KA	500-	04-09	500/600 XP, 600 EDGE, 600 RMK,	10 dents	35-507
#2202520	600		IQ, Switchback, Pro X, Fusion	petite roue dentée en laiton	
61-600KB	600ho	07-13	600 Cleanfire mod., Rush 600	10 dents	35-507
#2203320	2204098		600/700 IQ Dragon -08, Widetrack	petite roue dentée en laiton	
61-700KA	700	07-10	600/700 RMK, 700 IQ Dragon	10 dents	35-507
#2203578			600/700 Switchback		
61-700KB	600-	99-05	600/700 RMK/XC/XC SP	10 dents	35-507
#2201361	700		600/700 XC/DLC/Classic		
61-700KC	700-	2006	700 Fusion, 700 RMK		35-526
#2203110	900		900 Fusion		
61-600KR	600	08-09	600RR Euro, IQ Shift, RMK 144		35-507
#2203580					
61-800KA	800	08-12	800 Dragon, IQ, Rush, Assault	10 dents	35-522
#2203717	2203993, 2204621;				
61-800KB	800	00-05	800 RMK	centre solide	35-522
#2201554			heavy duty PTO bearing		



Rotax, Bielle de vilebrequin

1-cylindre F/C					roulem.
cc	année	PTO	Centre	MGT	aiguilles
253	1985-		722-2500		35-505
2-cylindres F/C					
377-447	1990-07	722-2503		722-2503	35-505
503	1979-	722-2504		722-2504	35-505
550	2003-	722-2515		722-2515	35-524
2-cylindres L/C					
440-500	2000-06	722-2505AP		722-2505AM	35-503
434-444	1975-80	722-2504		722-2504	35-505
454	1995-97	722-515AP		722-515AM	35-503
462	1986	722-2504		722-2504	35-505
467-532	1985-95	722-2502		722-2502	35-505
494	1996-00	722-2505AP		722-2505AM	35-503
500	2003	722-2505AP		722-2505AM	35-503
521-532-536	1983-99	722-2505		722-2505	35-505
537-582-583	1983-99	722-2505		722-2505	35-505
500SS-600	2003-11	722-516AP		722-516AM	35-507
600, 600HO	1999-07	722-2510		722-2509	35-507
500SSXP-600	2008-10	722-2510		722-2509	35-507
600 HO SDI	2004-11	722-2510		722-2509	35-507
600 HO E-Tec	2004-11	722-2510		722-2509	35-507
617-643	1991-92	722-2505		722-2505	35-505
670	1993-99	722-2507		722-2506	35-507
700	1999-00	722-2507		722-2506	35-507
700	2001-02	722-2510		722-2509	35-507
800 HO, SDI	2000-06	722-2510		722-2509	35-507
800 RPTEK	2007-11	722-2520		722-2520	-
1000 SDI	2005-07	722-2518		722-2518	-
3-cylindres L/C					
600-700	1996-98	722-2519	722-2519	722-2519	35-503
700	1999-00	722-2519	722-2519	722-2519	35-503
779	1993-96	722-2512	722-2511	722-2511	35-505
809	1997-03	722-2512	722-2511	722-2511	35-505

Graisse roulement du vilebrequin

35-900 Graisse 300 g

35-901 Graisse 50 g

Doit être utilisé lorsque Roulement PTO et / ou Roulement MGT est un espace clos.



Bielle de vilebrequin, dimensions, Rotax



P/N	Leng. C-C	upp dia	low dia	up wi.	low wid	pin dia.	pin length	upper bearing	lower bearing
722-2500	115	22	30	13	13	24	48	18x22x22	24x30x13
722-2503	115	22	30	15	15	24	47	18x22x22	24x30x15
722-2504	120	22	30	15	15	24	48	18x22x22	24x30x15
722-2505	125	22	31	17	17	24	52	18x22x22	24x31x17
722-2505AP	125	22	30	17	17	24	53	18x22x22	24x30x17
722-2505AM	125	22	30	17	17	24	55	18x22x22	24x30x17
722-2506	132	25	31	17	17	24	53	20x24x23	24x31x17
722-2507	132	25	31	17	17	24	55	20x24x23	24x31x17
722-2509	132	25	35	18	18	27	53	20x25x23	27x35x18
722-2510	132	25	35	18	18	27	55	20x25x23	27x35x18
722-2515	125	25	31	20	17	24	50	20x25x23	24x31x17
722-2518	144,5	29	40	23	23	30	64,80	24x29x23,4	30x40x23
722-2519	120	23	31	17	17	25	52/57	18x22x22	25x31x17
722-2520	132	27	40	20	20	30	57	22x24x24,8	30x40x20
722-516AP	125	25	30	17	17	24	55	18x22x22	24x30x17
722-516AM	125	25	30	17	17	24	53	18x22x22	24x30x17

Roulement à aiguilles

P/N	dimensions	pour piston
35-502	16 x 21 x 20	692,696,
35-503	18 x 23 x 22	601,691,693,694,695,699,774,781,782,707,710,711,712,713,715,718,719,727,
35-505	18 x 22 x 22	740,741,742,746,747,748,750,751,752,758,759,760,761,762,763,772,780,800,801,803,804,806,807,810,811,812,813,814,815
35-507	20 x 25 x 22,8	776,778,783,785
35-513	16 x 20 x 20	706,708,670,
35-514	15 x 19 x 20	745,
35-520	18 x 23 x 21	700,702,703,704,705,
35-521	20 x 25 x 24	808,816,817,818,825,826
35-522	16 x 20 x 22,5	689,802,
35-523	20 x 26 x 24	602,679,681,682,683,684,687,
35-524	20 x 24 x 22,7	773,779,
35-525	16 x 20 x 21,7	685,709,714,716,717,
35-526	22 x 27 x 25	730,
35-415R	21 x 27 x 24,7	09-7023 800R



Bielle de vilebrequin



Polaris Bielle de vilebrequin

2-cylindres F/C					
cc	année	PTO	Centre	MGT	needle
440-500	kaikki	724-2513		724-2512	35-503
550	2004-	724-2516		724-2516	35-503
2-cylindres L/C					
440	1993-97	724-2513		724-2512	35-503
500	1993-11	724-2513		724-2512	35-503
500-600	1998-09	724-2517		724-2517	35-507
600-700	1997-01	010-535		010-535	-
800	2000-05	010-538		010-538	35-526

Yamaha Bielle de vilebrequin

2-cylindres F/C					
535-540	1979-06	010-523		010-523	35-521
2-cylindres L/C					
500-570-600	1987-96	010-525		010-525	35-507
500-600	1997-	010-525		010-525	35-507

Arctic Cat Bielle de vilebrequin

2-cylindres L/C			3-cylindres L/C		
600 Carb	2004-06	3007-530		3007-530	b1074
600-700	2003-2010	3007-530		3007-530	
FF, CF 800	2007-2011	3007-530		3007-530	
800-900, ZR900	2001-2008	721-2500		721-2500	
M1000, F1000	2007-2011	3007-261		3007-261	
Thunder 1000	2000-2002	3007-530	3007-530	3007-530	

Bielle de vilebrequin, dimension, Polaris, Yamaha, Arctic Cat

P/N	Pit. C-C	up dia	low dia	upp wid.	low widt.	pin dia.	pin lengt	upper bearing	lower bearing
724-2510	112	20	32	16	16	24,3	49	16x20x22	24,3x32,3x16
724-2512	112	23	32	16	16	24,3	56	18x23x22	24,3x32,3x16
724-2513	112	23	32	16	16	24,3	57	18x23x22	24,3x32,3x16
724-2516	120	23	32,3	16	16	24,3	57	18x23x22	24,3x32,3x16
724-2517	128	25	35	17	17	28	/	20x25x23	28x35x17
010-535	125	25	35	16	16	28	60	20x25x22	28x35x16
010-538	136	27	35	18	18	27	60	22x27x25	27x35x18
010-523	120	25	31	20	20	24	59	20x25x24	24x31x20
010-525	125	25	32	20	20	25	60	20x25x24	25x32x20
721-2500	146,5	25	39	22	22	30	/	24x29x23,8	30x39x22
3007-530									
3007-261									



New for season

Piston	Grandeur		Engine	Gasket	Oil seals	Needle	Taiwan
09-7048	Bore 65,00	2	453 (440)	710-258	55205	35-505	N/A
Lynx Racing 440 1998-04, Lynx Rave 440 2005-06							
09-7045	Bore 69,50	2	494 Rave	710-212	55190	35-505	09-780
09-7045-050	Bore 70,00		Compression height 32,50 mm				
09-7045-100	Bore 70,50		XR 500LC 2000, Ranger LCE 2001-02				
Cobra Ultra 1996, Glx 5900 LC 1996-99, Enduro 500 1997-99, Lynx ST 500 2002							
Enduro 500 1997-99, G-Touring 500 1998-00							
09-7028	Bore 69,50	2	493 Rave	710-256	55205	35-505	08-784
09-7028-050	Bore 71,00		Compression height 30,50 mm				
09-7028-100	Bore 71,50						
Lynx 5900 ST 2000, Enduro 500 2001-05, Gr Tour. 50 2001-02, Enduro 500RER -02							
09-7047	Bore 76,00	2	593 Rave	710-259	55216	35-507	09-785
09-7047-050	Bore 76,50		ST 600 2002-07, GR Tour. 600 2001-02,				
09-7047-100	Bore 77,00		Enduro 600RER 2002, Ranger LCE 2003				
Enduro 600 SP 2000-02, Super Touring 600 2001-2003, Lynx 5900 ST 2001							
Ranger 600 2004-06, Adventure 600 2006, Rave 600 2006-							
09-7053	Bore 72,00	2	593 Rave RS	710-278	55204	35-507	N/A
Lynx Rave 600 RS 2008-							
09-7021	Bore 72,00	2	600 SDI, HO	710-278	55204	35-507	06-776
			600 E-Tek	710-303	55230		
Enduro 600SP 2003-04, Enduro 600 HO SDi 2004-05, Sport Touring 600 2003-05							
Sport Tourer 600 2003-05, Adventure 600 SDi 2006-08, Rave 600 SDi 2006-08							
XTRim 600 SDi 2006-08, Yeti 600 SDi 2006-08, Rave Re, SC 600 SDi 2007-08							
Gr Tourer 600 SDi 2009-2010, Rave E-Tec 600 2009-2012, XTRim 600 E-Tec 2011-12							
Commander 600 E-Tec 2012-13, XTRim Commander 600 E 2009-2011							
49 Ranger 600 E-Tec 2011							
09-7056	Bore 78,00	2	670 93-94	710-197	55105	35-524	09-773
09-7056-050	Bore 78,50		670 95-96	710-293	55190		
09-7056-100	Bore 79,00		670 97-00	710-215	55190		
Rave 670 1994-97, Snow Cross 1996, Grand Touring 1997, Rave Big Pipe 1998-99							
Grand Touring Royal 1998-99, Rave Special 2000, G-Touring 700 2000.							
09-7049	Bore 78,00	2	693 2000-02	710-255	55204	35-507	09-783
09-7049-050	Bore 78,50		693 2003-04	710-255	55217		
09-7049-100	Bore 79,00						
Super Touring 700 2001-02, Enduro 700 2001-02, Enduro 700 RER 2002							
09-7022	Bore 82,00	2	793 2003-07	710-261	55217	35-507	09-778
09-7022-050	Bore 82,50		793 2000-02	710-261	55204		
09-7022-100	Bore 83,00		Ranger Mountain 2003-04, XTRim 800 PTek 2006-07				
Rave 800 2001-04, Rave 800 SDi 2005, RC 800 PTek 2006-07, Enduro 800 2001-02							
Super Touring 800 2002, Sport Touring 800 2003-04, Adventure 800 2005							

Lynx - Rotax 1996-2014 Wössner Pistons forgés



Piston	Grandeur		Engine	Gasket	Oil seals	Needle	Taiwan
09-7060	Bore 82,00	2	800 R 2013-	09-7060 replaces piston 09-7023			
09-7023	Bore 82,00	2	800 R	710-302	55229	35-415R	N/A
09-7023-050	Bore 82,50		800 R E-Tek	710-312	55229		
09-7023-100	Bore 83,00						
09-7023-300	Bore 85,00		Boondocker 800R E-Tec 12-13, Rave 800R E-Tec 12-13				
Rave 800R 08-11, XTRim 800R 2008-2010, Boondocker 800R 2011, GLS 3300 2013							
09-7046	Bore 76,00	2	550 F/C	710-277	55215	35-507	09-779
09-7046-050	Bore 76,50						
09-7046-100	Bore 77,00						
Enduro 550 F 2003-05, Rave 550 2006-2012, 550 SUV 2003, ST 550 2004-07							
Lynx 6900 2004-06, Ranger 550F 2003-09, Explorer 550F 2003-05, Forest Fox 2005							
XTRim 550 2006-2012, Adventure 550 2006-09, Yeti 2008-2011							
08-6002	Bore 82,00	2	Rotax 747 Z	Seadoo 718 piston 1996			
08-6002-050	Bore 82,50			Cylinder height 121,3 mm			
08-6002-100	Bore 83,00						
08-6001	Bore 82,00	2	Rotax 747 Z	Seadoo 780 piston, 1997-2000			
08-6001-050	Bore 82,50			Cylinder height 123,4 mm			
08-6001-096	Bore 82,96						
Lynx Racing 747 Z, 1996-2000. Engine powered by Totaltek. Ca. 65 engines							

Skidoo - Rotax 1996-2014 Wössner Pistons forgés



Piston	Grandeur		Engine	Gasket	Oil seals	Needle	Taiwan
09-7048	Bore 65,00	2	453 (440)	710-258	55205	35-505	N/A
MXZ 440 LC X 1998-07							
09-7045	Bore 69,50	2	494 Rave	710-212	55190	35-505	09-780
09-7045-050	Bore 70,00		Compression height 32,50 mm				
09-7045-100	Bore 70,50		Scandik WT 1998-99, Formula 500 LC 2000				
Formula Mach Z 3-syl 779 Rave 1993-96, Grand Touring 500 1996-99, MXZ 500 98-99							
Formula SLS 1996, Summit 500 1997-99, Formula 500 DLX 1998-99							
09-7028	Bore 69,50	2	493 Rave	710-258	55205	35-505	08-784
09-7028-050	Bore 70,00		Compression height 30,50 mm				
09-7028-100	Bore 70,50						
MXZ 500 00-03, Touring 500 00-03, Scandik WT 2000							
09-7047	Bore 76,00	2	593 Rave	710-259	55216	35-507	09-785
09-7047-050	Bore 76,50		Summit 600 1999-01, MXZ 600 1999-02,				
09-7047-100	Bore 77,00		Formula Z, DLX 600 2000-01				
Grand Touring 600 2000-03, Scandik 600 WT, SUV 2001-07, Legend GT 500 SS 2004							
MXZ 500 Rev SS 2004-06, GTX 500 SS 2005-07, TNT 2008-09, Summit 500 SS 2009							



Piston	Grandeur		Engine	Gasket	Oil seal	Needle	Taiwan
09-7053	Bore 72,00	2	593 Rave RS	710-278	55204	35-507	N/A
MXZ RS 600 2008-2013							
09-7021	Bore 72,00	2	600 SDI, HO	710-278	55204	35-507	09-776
			600 E-Tek	710-303	55230		
Summit 600, RER, Adr. 2003-08, Renegade 600, X 2003-08, MXZ 600 REV-X 2003-06							
Legend GT 600 2004-, GTX 600 2005-08, Expedition YETI 600 SDi 2006-07							
MXZ 600 HO, RS-X 2007-08, Expedition 600 TUV 2008-, MXZ 600 E-Tec 2009-10							
Renegade 600 E-Tec 2009-12, Summit 600 E-Tec Everest, SP 2009-12							
Expedition 600 SDi, LE 2010-12, Grand Touring LE 2012-							
09-7056	Bore 78,00	2	670 93-94	710-197	55105	35-524	09-773
09-7056-050	Bore 78,50		670 95-96	710-293	55190		
09-7056-100	Bore 79,00		670 97-00	710-215	55190		
Mach I X 93, Mach I 93-96, MXZ 670 96-98, Grand Touring SE 94-96, Formula SS 95-96							
Formula Z 670 98-99, Summit 670 96-99							
09-7049	Bore 78,00	2	693 2000-02	710-255	55204	35-507	09-783
09-7049-050	Bore 78,50		693 2003-04	710-255	55217		
09-7049-100	Bore 79,00						
Grand Touring 700 2001-, Renegade 700 2002							
Summit 700 2000-01, Formula DLX 700 2000-01, MXZ 700 2001							
09-7022	Bore 82,00	2	793 2003-07	710-261	55217	35-507	09-778
09-7022-050	Bore 82,50		793 2000-02	710-261	55204		
09-7022-100	Bore 83,00						
Summit 800HM, X, 162, Adr. 2000-07, MXZ 800X 2001-02, Renegade 800X 2002-07							
Grand Touring 800 2002-03, MXZ 800 REV-X 2003-07, Legend GT 800, GTX 800 05-07							
09-7060	Bore 82,00	2	800 R 2013-	09-7060 replaces piston 09-7023			
09-7023	Bore 82,00	2	800 R	710-302	55229	35-415R	N/A
09-7023-050	Bore 82,50		800 R E-Tek	710-312	55229		
09-7023-100	Bore 83,00						
09-7023-300	Bore 85,00						
MXZ 800 R X 2008-10, Renegade 800 X-XP 2008-10, Summit 800 X-XP 2008-10							
09-7046	Bore 76,00	2	550 F/C	710-277	55215	35-507	09-779
09-7046-050	Bore 76,50						
09-7046-100	Bore 77,00						
Summit 550F 2003-08, MXZ 550 F, X 2003-09, Grand Touring 550F 2003							
Legend GT 550F 2004, Scandik WT 550, SUV 2003-09, Alpine IV 2004-05							
GTX 550F 2005-09, Freestyle, Back Country 2006-08, Tundra 2006							
Expedition Sport 2007, Scandik WT 600 2007, TNT 550 F 2010-12							
Renegade 550 Sport 2010-12, Grand Touring Sport 550F 10-12, Scandik Tundra 10-12							
09-7050	Bore 88,00	2	Rotax 997	710-289	55226	3008-583	N/A
Renegade 1000 X 2006-07, Mach Z 1000 2006-07, Summit 1000 HM 151, 162, 06-07							

New for season

Piston	Grandeur		Engine	Gasket	Oil seals	Needle	Taiwan
09-7040	Bore 70,50	2	500 99-01	710-237	55194	35-521	09-720
09-7040-050	Bore 71,00		500 02-07	710-250	55194		
XC 500, SP, X, 1999-03, 500 SKS, E, 00-01, XC 500 SP RACE 2004-06							
09-7015	Bore 73,00	2	544 99-03	710-238	55196	35-503	09-727
09-7015-050	Bore 73,50		544 03-13	710-286	55218		
09-7015-100	Bore 74,00		Sport Touring, E, 2000-04, Trail Touring, DLX 2000-09, 550 Super Sport Edge 2001-02, PRO X 550 2004, RMK 550 2004-07				
IQ 550 SHIFT, LXT 2010-12, 550 Transport 2010-11, Super Sport, X, 1999-07							
09-7016	Bore 74,50	2	600	710-230	55193	35-507	09-721
600 XC Special 1998-99							
09-7017	Bore 77,25	2	600 00-06	710-251	55194	35-507	09-728
			600 07-09	710-297	55219		
			CFI 07-08	710-298	55225		
			IQ 08-12	710-305	55225		
HO IQ Touring CFI 2007-, XC 600 SP, EDGE 2000-07, 600 Classic, Touring 2001-06, XC 600 X M10 2002, PRO X 600 2003-04							
XC 600 SP X 2003-, RMK 600 2004-07, 600 Switchback 2004-07; All 600cc 00-13							
XC 600 XP RACE 2005-, HO Fusion, IQ 600 2006-07, HO IQ 600 CFI 2007-							
09-7055	Bore 73,80	2	600 08-13	710-305	55225		N/A
IQ Racer 600							
09-7018	Bore 81,00	2	700 99-01	710-231	55193	35-507	09-722
09-7018-050	Bore 81,50		700 02-05	710-265	55193		
09-7018-100	Bore 82,00		XC 700, SP 1999-00, 700 SKS 1999-00,				
09-7018-300	Bore 84,00		RMK 700 1997-00, INDY XC 700 1998-03				
INDY 700 SKS 1998-03, PRO X, X2 700 2003-05, Switchback 700 2004-05							
09-7031	Bore 81,00	2		710-298	55225	35-526	N/A
Dragon 700 2007-08, RMK 700 2007-2010							
09-7041	77,50		700	710-288	55214	35-526	N/A
09-7041-100	78,50						
RMK 700, 2006, Fusion 700 2006,							
09-7043	Bore 72,00	3	794	710-254	55186	35-503	09-731
XCR 800 3-syl 1999-00							
09-7019	Bore 85,00	2	794	710-252	55193	35-526	09-730
09-7019-050	Bore 85,50		800 RMK 2000-, XC 800 SP EDGE, X, 2001-02,				
09-7019-100	Bore 86,00		PRO X 800 2003-04				
800 Touring 2004-05, 800 Switchback 2005-08.							
09-7044	Bore 85,00	2	800 08-09	710-306	55225	35-526	N/A
			800 10-12	710-310	55225		
Dragon 800, Assault 800 All, RMK 800, RUSH 800 2009-							
09-7020	Bore 83,00	2	900	710-282	22214	35-526	N/A
09-7020-100	Bore 84,00		900 RMK 05-06, Fusion 900 05-06, Switchback 900 2006				



Yamaha 1996-2014 Wössner Pistons forgés

Piston	Bore		Engine	Gasket	Oil seals	Needle	Taiwan
09-7024	Bore 68,00	2	500 L/C	710-200	55188	35-521	09-829
Venture 500 1998-01, VMax 500 XTC, DX 1998-, SRX 500 1999, SX 500 R 2000-01							
09-7057	Bore 72,00	2	485 F/C			35-505	09-813
09-7057-050	Bore 72,50						
09-7057-100	Bore 73,00						
Mountain Lite 97-99, Phazer 84-01, Venture 91-03, XL-V 91-93							
09-7058	Bore 73,00	2	535		55133	35-521	09-808
09-7058-050	Bore 73,50		SRV-90	710-167			
09-7058-100	Bore 74,00		VK 88-05	710-182			
EC540 79-84, SR540 80-91, XL540 85-90, VK540 1988-2007, Viking III -2014							
09-7025	Bore 74,80	2	598 L/C	710-201	55188	35-521	09-826
VMax 600 DX, ST, XT, XTC 1994-98, Mountain Max 600 1996-99, Venture 600 97-98							
09-7051	Bore 65,00	3	600 3-syl	710-240	55198	35-507	09-830
SRX 600 1999, Venture 600 1999-04, VMax 600 DX 1999-00, SX 600 R 2000-02							
09-7026	Bore 70,50	3	698 3-syl	710-241	55198	35-507	09-828
Mountain Max 700 1996-02, VMax 700 XTC, DX 1998-01, Venture 700 1998-03							
SX 700 R 2000-01							
09-7027	Bore 69,00	3	696 3-syl	710-246	55199	35-507	09-831
09-7027-100	Bore 70,00						
09-7027-400	Bore 73,00		VMax 700 SX 1997,				
Mountain Max 700 1999, Mountain SRX 700 1998-99, SRX 700 1998-99							
09-7052	Bore 69,00	3	700 3-syl	710-269	55199	35-507	N/A
09-7052-100	Bore 70,00		Venture 700 2004-				
SRX 700 2000-02, SXViper 700, ER 2002-04, SXViper Mountain 2003-04							
09-7501	Bore 77,00	2	499	711-299	N/A	35-507	N/A
Phazer GT 2007, Phazer Mountain Lite 2007, Phazer FX, MTX, FTX, R-TX 2007-10, Phazer Multipurpose 2007, Venture Multipurpose 2008-10, Venture Lite 2008-10							
09-7502	Bore 74,00	3		711-314	N/A	N/A	N/A
RX-1 Mountain 2003-04, RX-1 ER 2003-06, RX-1 2003-, RX Warrior 2004-06							
09-7503	Bore 75,00						
RX-1 Mountain 2003-04, RX-1 ER 2003-06, RX-1 2003-, RX Warrior 2004-06							
09-7504	Bore 74,00						
RX-1 Mountain 2003-04, RX-1 ER 2003-06, RX-1 2003-, RX Warrior 2004-06							
09-7505	Bore 75,00						
RX-1 Mountain 2003-04, RX-1 ER 2003-06, RX-1 2003-, RX Warrior 2004-06							



Arctic Cat 1987-2014 Wössner Pistons forgés

Piston	Grandeur		Engine	Gasket	Oil seals	Needle	Taiwan
09-7001	Bore 65,00	2	431 F/C	wwwpage	55109	35-502	09-696
Jag AFS, 440, 87-99, S. Jag 87-97, Z440 95-98, Bearcat 440,93-00, Panther 440 -01							
09-7002	Bore 68,00	2	435 L/C	wwwpage	wwwpage	35-502	09-695
Pantera 440 1985-90, El Tigre 5000 440 1987-89							

Arctic Cat 1987-2014 Wössner Pistons forgés

Piston	Grandeur		Engine	Gasket	Oil seals	Needle	Taiwan
09-7034	Bore 66,50	2	440 L/C	710-273	55203	N/A	N/A
ZL 440 97-00, Jag 440 96, Cougar 91-94, Cheetah Tour. 91-94, Z 440 ESR 03-04							
09-7004	Bore 71,00	2	497 L/C	wwpage	wwpage	35-xxx	35-605
ZRI 500 1998-2000, Powder Special 500 EFI 2000							
09-7035	Bore 71,00	2	499 L/C	wwpage	55222	35-xxx	N/A
ZR 500 01-02, Sabercat 500, EFI, LX 03-06, M5, M5 EFI 05-06, F5 EFI, F5 EFI LXR 2007-10, CF EFI 07-09, Snopro 500 2010-13, T500 08-09							
09-7005	Bore 73,40	2	550 L/C	710-189	55176	35-523	09-687
Bearcat 550 -95-2002, EXT 550 1992-96, ZL 550 2000-03							
Pantera 550 1991-2005, Panther 550 1997-2001, Prowler 2-up 1995							
09-7037	Bore 75,40	2	581 L/C	710-189	55176	35-523	09-681
Prowler 580 1996, EXT 580 1993-98, ZR 580 1993-97, Pantera 580 1996-98							
09-7006	Bore 66,50	3	594 3-syl	710-216	55176	35-503	09-601
Triple Touring 600 1999-2000, ZRT 600 1996-2000							
09-7007	Bore 78,00	2	599 L/C	710-227	55176	N/A	N/A
09-7007-050	Bore		Powder Special 600 1998-2000, ZR 600 1998-99				
09-7008	Bore 78,00	2	599 L/C	710-249	55203	N/A	35-609
Mountain Cat 600 2001-04, Pantera 600 EFI 2002-05							
Powder Special 600 EFI, ZR / ZL 600 EFI 2000-03							
09-7054	Bore 73,70	2	600 L/C	710-304	55223	N/A	N/A
Sno Pro 600 2009-14							
09-7009	Bore 79,70	2	698 L/C	710-275	55221	35-526	09-657
Sabercat 700 EFI 2004-06, Crossfire7 2006, F7 Firecat 2004-06, M7 2005-06							
09-7010	Bore 81,00	2	699 L/C	wwpage	55173	35-523	09-682
09-7010-050	Bore 81,50		Powder Special 700 99-00, ZR 700 99-00,				
09-7010-500	Bore 86,00		Wildcat 700 M.C, EFI 91-96, ZL 700 -00				
09-7011	Bore 81,00	2	785 L/C	710-262	55207	N/A	09-611
09-7011-500	Bore 86,00						
ZL 800 EFI, ESR 02-03, ZR 800 01-03, Mt Cat 800, EFI 01-04, Pantera 800 EFI 02-04							
09-7012	Bore 72,00	3	794 3-syl	710-287	55182	35-523	09-602
ZRT 800 1995-2001, Pantera 800 1998-99, Thundercat M.C 1996							
09-7038	Bore 85,00	2	784 L/C	710-295	55223	N/A	N/A
F8 EFI Snopro 07-09, M8 Snopro 09, CF 8 Snopro 09, Crossfire 800 07-08, 794cc-2009							
09-7059	Bore 85,00	2	784 L/C	710-311	55223	N/A	N/A
CF8 2010- , F8 2010- , M8 2010- , M800 2012-, F800 2012-, XF800 2012-							
09-7030	Bore 85,00	2	862 L/C	710-262	55207	N/A	
Mt Cat 900 03-04, King Cat 900, EFI, Snopro 04-06, ZR 900, EFI 03-06, ZR 900							
09-7039	Bore 76,50	3	895 3-syl	710-193	55173	N/A	N/A
09-7039-400	Bore 80,50						
09-7039-450	Bore 81,00		Thundercat 900 1993-97, Thundercat 900 1993-97				
09-7013	Bore 81,00	3	993 3-syl	710-193	55182	N/A	N/A
09-7012-400	Bore 85,00						
Thunder Cat 1000 M.C 98-02, Mountain Cat 1000 01-02, Pantera 1000 00-01							
09-7014	Bore 90,31	2	1000 L/C	710-296	55224	N/A	N/A
Crossfire 1000, F1000, M1000 2007-2009							

Hi-Performance Wössner Pistons forgés Sea-doo-Jet Ski

Arctic Cat	piston p/n	cyl	cc	bore	gasket, full set
SX-R800 03-11	08-6010	2	782	82,00	
JS900, ZXI900 95-97,	08-6009	3	891	73,00	08-611502
STX900 96-06, STS900 01-02					
ZXI1100 90-03, STX110097-03	08-6007	3	1071	80,00	
Also over size every 0,5 mm					
Skidoo, Seadoo					
XP/GTI/HX/SPX/GTS/GS/GSI 95-03	08-6002	2	718	82,00	08-611204
Over size 0,50 mm	08-6002-050				
Over size 1,00 mm	08-6002-100				
XP/SPX/GSX/GTX/GTX/GTI 97-03	08-6001	2	780	82,00	
Over size 0,50 mm	08-6001-050		800 Carbu		08-611205
Over size 0,96 mm	08-6001-096		800 RFI new		08-611209
GSX-LTD/XP-LTD/GTX-LTD 97-05	08-6011	2	951	88,00	
LRV/RX950 97-05, Sporster950 00-03, VSP950 99-03			951 Carbu		08-611206
Over size 0,50 mm	08-6011-050		951 DI		08-611210
Over size 1,00 mm	08-6011-100				
Polaris					
SL 700, Virage, 96-04	010-832	2	700	81,00	08-611804
SL 750, SLT, MSX110-150 93-04	010-830	3	750	69,75	08-611802
Octane, Virage 777, 02-04	010-835	3	800	84,00	08-611807
SL 780, SLT 780, 96-97	010-834	3	780	71,50	08-611803
SL 1050, SLX, SLTX, 96-98	010-832	3	1050	81,00	
Genesis 1200, 99-04	010-835	3	1200	84,00	08-611809
Genesis 1200, 02-04	010-835-07	3	1200	85,00	08-611812
Kawasaki					
JS750 SS, SSXi, ST, SX, XIR 92-95	08-6006	3	750	80,00	08-611407
SX-R800 03-11	08-6010	2	800	82,00	08-611409
JS 900, ZXI, STS, STX 95-06	08-6009	3	900	73,00	08-611404
ZXI 1000, STX, Ultra 96-04	08-6007	3	1100	80,00	08-611405
Ultra 150 STX-R, 95-05		3	1200	80,00	08-611411
Yamaha					
Super Jet 700 93-10, Wave Runner	08-6005	2	701	81,00	08-611605
Wave Blaster 700, Wave Venture XL700 02, 700 mallit 93-98					
Wave Runner 1100 95-97	08-6005	3	1100	81,00	08-611604
Over size 0,50 mm	08-6005-050				
Over size 1,00 mm	08-6005-100				
GP800R 98-05, XL, XLT800 00-04	08-6004	2	800	79,90	08-611607
Over size 0,50 mm	08-6004-050				
Over size 1,00 mm	08-6004-100				
XL, XLT 1200 98-05	08-6004DD	3	1200	79,93	08-611608
GP 1300R 03-08	08-6003	3	1300	83,90	08-HLYG1300

Seadoo; Vilebrequin, roulement à billes

Sea-Doo	année	PTO	Centre		MGT
587 L/C bag labyr. tai T-Crank	88-96	6207NCR4 X 2	6206NCR4	6206NCR4	6206NCR4 x 2
650 L/C	93-96	6207NCR4 X 2	6206NCR4	6206NCR4	6206NCR4 X 2
717 L/C	95-05	6207PC4 X 2	6206PC4	6206PC4	6206PC4 X 2
787 L/C Big gear, 787 L/C	95-99	6306PC4, 6207PC4	6207PC4	6207PC4	6207PC4 X 2
951 L/C, 947 DI Big gear	98-05	6208PC4 x 2	6306PC4	6208PC4	6208PC4 X 2
Arctic Cat					
639, 640 L/C 2-cyl		6207PC4	6207GPC4	6207PC4	6207PC4
770 L/C 2-cyl		85B551A35mm	85B551A35mm	85B551A35mm	85B551A35mm
900, 1000, 1100 L/C 3-cyl		6209/1DRIN	6209/1DRIN x2	6209/1DRIN x2	6306/1DYRI
Kawasaki					
JS 440- JS 550	86-95	6206NRC4	6305NRC4	6305NRC4	6206NRC4
JS 650 thread 18 mm	92-97	6306C4	6306C4	6306NRC4	6306C4
JS 750, JS 800, 2-cyl		6306NRC4	6306NRC4	6306NRC4	6306NRC4
JH 900 3-cyl		6307PC4	6207PC4 X 2	6207PC4 X 2	5207PC4
JH - JT 1100, JS 1200 3-cyl		6307PC4	6207PC4 X 2	6207PC4 X 2	5207PC4
Polaris 3-cyl					
700 L/C USA	97	6027C4 X 2	6207C4	6207NRC4	6207C4 X 2
800 L/C	02-04	6207C4 X 2	6207C4	6207NRC4	6207C4 X 2
650 - 750 - 780 L/C	92-97	6307GPC4	6207PC4 X 2	6207PC4 X 2	6207PC4 X 2
785 SP BLACK ENGINE		6307GPC4	6207PC4 X 2	6207PC4 X 2	6207PC4 X 2
900 - 1050 L/C USA	96-98	6207C4 X 2	6207C4 X 2	6207C4 X 2	6207C4 X 2
1200 L/C		6207C4 X 2	6207C4 X 2	6207C4 X 2	6207C4 X 2
Yamaha					
650 - 700 - 760		83A726-E	6207R9	6207R9	83B207
800 2-cyl		6308GPC4	6208PC4	6208PC4	5207PC4
1100 - 1200 3-cyl		83A726-E	6207R9 X 2	6207R9 X 2	83B207 S
1200 GR 3-cyl		6308GPC4	6208PC4 X 2	6208PC4 X 2	OEM

Pieces# Dimentions

6206PC4	30 x 62 x 16	5207PC4	35 x 72 x 27	83A726-E	35 x 80 x 21
6206NRC4	30 x 62 x 16	6305NRC4	25 x 68 x 17	83B207	32 x 72 x 30
6207C4	35 x 72 x 17	6306/1DYRI	30 x 75 x 19	85B55135mm	35 x 75 x 17
6207PC4	35 x 72 x 17	6306C4	30 x 72 x 19	6209/1DRIN	45 x 90 x 19
6207R9	35 x 72 x 17	6306PC4	30 x 72 x 19	6308GPC4	40 x 90 x 23
6207NRC4	35 x 72 x 17	6307PC4	35 x 80 x 21		
6208PC4	40 x 80 x 18	6307GPC4	35 x 80 x 21		

Vilebrequin web, motoneige



09-187 Rotax 503

09-1880 Rotax 670

09-1881 Rotax 800HO

09-1882 Rotax 500 + 600

09-1883 Rotax 700

09-1884 Rotax 800R



Polaris

09-241 Polaris XC500+XC600

09-185 Polaris XC800

09-186 Polaris XC700

Nicasil Cylindres Replaqués



Nicasil Cylindres Replaqués

always old core is needed:

- not broken shirt
- also modified, marked
- to be welded,



Garantie à vie (conditionnel)

Rotax	part no:	année	modèle
60-440A	923720	99-06	440 MXZ X 440 Racing
60-550A		03-13	550 F/C, note: 0,50 mm od, f.ex. Wössner
60-600A	613710	03-06	600 HO engine
	613712		
	613714		
60-600B	613940	04-07	600 HO SDI engine
	613942		
	613944		
60-600C	623262	2009	600 E-Tek,
60-600C	263262	2010	600 E-Tek; A hole in the power valve for lubrication
60-600E	623263	2010-	600 E-Tek
60-600F	623480	08-10	600 RS
60-600FA	623481	2011	600 RS
60-600FF	623482	2012	600 RS
60-700B	923691	2000	700 pin 8 mm
60-700C	923692	00-04	700 pin 10 mm
	923693		
	923695		
60-800A	923813	03-04	800 SE SDI, Legend, Grand Touring
60-800B	923810	00-04	800 MXZ, Legend 800, Summit 800 HO
	923811		
	923815		
	923817		
60-800D	613852	05-07	800 HO PTEK, Ardenaline, Renegade, Summit
60-800G	613852	05-07	800 HO, Techmaster casting
60-800E	413041	07-13	Replace all numbers to follow:
monobloc	623240	07-13	800R, monobloc MXZ X 800 R
	623241	07-13	6 mm exhaust bolts, use 8 mm bolts
	623242	07-13	800R, PTEK, monobloc
	623246	07-13	800R, PTEK, Techmaster, 8 mm exhaust bolts,
	623249	07-13	800 R E-Tek, monobloc (623246)
	413042	07-13	
	413046	07-13	
60-1000A	613744	06-07	Mach Z 1000 SDi
60-1000B	613746	06-07	Summit 1000 SDi, MXZ Renegade 1000



Nicasil Cylindres Replaqués

Polaris	#piece	année	modèles
61-440B	3021604	05-07	440, IQ440
61-440C	3021304	02-04	440, PRO X 440
61-500B	3021185	2001	500, XC SP
61-500C	3021256	2002	500, XC SP, M10
61-500D	3021334	03-07	500-600, XC SP, EDGE
61-550A	3089934	07-11	550, Edge, 550 IQ, Supersport, Trail
61-600B	3021087	00-01	600, XC PRO X 2000-2001
61-600C	3021257	2002	600, XC PRO X 2002
61-600D	3021333	03-06	600, PRO X
61-600E	3021542	06-09	600, HO, Fusion, RMK, IQ, RR
61-600G	3021718	07-13	600, HO IQ Cleanfire
61-600R	3022206	10-13	600, Rush, Widetrack IQ
61-600S	3022305	12-13	600, RMK, Rush, Switchback
61-700A	3021866	08-11	600-700, RMK, Dragon, Switchback
61-700B	3021220	97-98	700 RMK, SKS, XP
61-700C	3021824	99-01	700 RMK, SKS, XC, XC SP, XC DLX, Classic
61-700K	3021367	04-05	700, Pro X, XC SP, XC Edge
61-700R	3021767	07-08	700, RMK, Dragon, Cleanfire
61-800A	3022201	2010	800 Dragon, Assault, Switchback, IQ
61-800B	3021064	00-01	800, RMK, XC SP
61-800D	3021339	03-05	800 Pro X, RMK, XC Edge, XC SP, Pro XC
61-800H	3021843	08-09	800, monoblock, Assault RMK, 800 Dragon SP, IQ
61-800R	3022205	2011	800, monoblock, Assault, Rush
61-800S	3022352	2012	800, monoblock Assault, Rush, RMK
61-800T	3022449	2013	800, monoblock Assault, Rush, RMK
61-900A	3021563	2006	900, Fusion
61-900B	3021576	05-06	900, Fusion, RMK



Nicasil Cylindres Replaqués

always old core is needed:

- not broken shirt
- also modified, marked
- to be welded,

Garantie à vie
(conditionnel)

Arctic Cat				
63-370A	3005453	8847	99-08	Z370, Panther 370
63-500A	3006422	95BO	03-06	500, Firecat 500, SP
63-570A	3005999	94BO	02-11	570, Bearcat 570, Z570, Panther 570
	3007479			
63-600A	3005653	88BA	01-05	600, ZL-ZR 600 EFI, Pantera 600 Efi
63-600B	3006643	96BO	04-11	600, Firecat 600, Sabercat 600, M6 Efi
63-600D	3007717		09-11	600 SP, Cross Country
63-700B	3006492	96B1	03-06	700, CF 700, Firecat 700, Sabercat 700
63-800B	3007522	98BO	07-09	800, CF 800, F8 Efi, M8
63-800C	3007849	98B4	10-13	800, CF8, CF 8 Snopro, M8, F8 LXR
63-900A	3006696	88J5	04-06	900, ZR 900 Efi, King Cat 900, MC 900

Arctic Cat



07-100 01
JAG 87-91, 0109-926

Polaris:



07-100 05
VM 38 SS, 3083171

Rotax



07-100 10
VM 34 straight



07-100 11
VM 34, 570.1262.00



07-100 12
VM 570.1261.00



07-100 13
SKID. VM 30, 32, 34 HD



07-100 20
TUNDRA VM 34



07-10021 MX 85-92



07-100 22
VM34,79-84, 570.1339.00



07-100 23
VM 40, 44, 570.038.200

Épaulement de caoutchouc



VM 30, 32, 34 HD
07-100 13

Yamaha



07-100 13
VM 30, 32, 34 HD



07-100 13
VM 30, 32, 34 HD

Kumikurkkujen sopivuus
selviää mallikohtaisesti

www.teolehtimaki.fi

ja siellä avaat kyseisen
kelkan sivun. Samalla
saat selville muut siihen
sopivat varaosat.

Pistons de motoneige: Taiwan

- super qualité, anneaux, axe de piston
- mos 2 surface

Nouveaux pistons pour 2013-2014:

- 09-650 Bearcat 570
- 09-657 F7 Firecat
- 09-776 Rotax 600 H.O, E-Tec
- 09-778 Rotax 800 H.O.

Arctic Cat	Bore	Engine	Gasket set	Oil seals	needle
09-602	72,00	794 3-syl	710-193	09-55182	35-523
Pantera 800 1998-01 ZRT 800 1995-01					
09-657	79,70	698 2-syl	710-275	09-55221	35-503
Crossfire 7 -06, F7 Firecat 2003-06, Sabercat 2004-06, M72005-06					
09-682	81,00	699 2-syl	710-180; -91-96; 710-267; -97-01	09-55173	35-523
Wildcat 700 MC. EFI 1991-96, ZR 700 1995, ZL 700 2000, ZR 700 1999-00					
09-684	78,00	650 2-syl	710-180	09-55175	35-523
Wildcat 650 1988-90, Mountain Cat 1990					
09-601	66,50	594 3-syl	710-216	09-55176	35-503
EXT 600 Tr. 97-98 EXT 600 Triple Touring 1998 Powder EXT 600 1997-98 ZRT 600 1995-98					
09-681	75,40	580 2-syl	710-189	09-55176	35-523
EXT 580 MC; EXT 580 EFI MC 1993-97; 580 Powder SP 1995-97; ZR 580 1993-97; Pantera 580 1995-97					
09-650	73,75	565 F/C 2-syl	710-270	09-55212	35-503
Bearcat 570 2004-09, F570 08-, Mountain Cat 570 2002-, T570 2008-, Z570, LX, Panther 570 2002					
09-683, 687	73,40	550 2-syl	710-189	09-55176	35-523
EXT special 1991-92 ; Pantera 550 2002-05, Panther 550 2000-01, ZL 550 ESR 2000-03; Bear Cat 550WT 2000-					
09-679, 605	71,00	497 2-syl	710-227; -98-01; 710-266	09-55203	35-523
ZL 500 EFI 1998-01; ZR 500, ERSI 1998-01; Powder SP 500 EFI 1999-01					
09-699	72,00	529 2-syl	710-063D	09-55112	35-503
Cheetah LC 1986-89; El Tigre 6000 1986-89; El Tigre EXT 1989-91; El Tigre Ext Mountain Cat 1990					
09-691	70,00	500 2-syl	710-063E	09-55109	35-503
Cheetah FC, Cougar 1986-90					
09-693	70,00	500 2-syl	710-063	09-55109	35-503
Panther 1986-88; Pantera el. 1980; Manx 2000S 1977-80, El Tigre 6000 LC 1980-85; El Tigre 5000 1977-81					
09-694	70,00	500 L/C 2-syl	710-063C	09-55112	35-503
El Tigre 6000 LC 1980-85					
09-689	68,00	440 2-syl			35-522
El Tigre 440 Z 1975-77; Kawasaki Intriguer, Intruder, Invader; Drifter 440 1978-81					
09-695	68,00	440 2-syl	710-063A	09-55112	35-503
Panther 440 LC 1996; ZL 440 1997-99; Prowler 1990-94; Jag 440 LC; El Tigre 6000 LC 1978-79; Jag 4000 FC 80-81					
09-696	65,00	431 2-syl	Tarkista netti	09-55109	09-502
Bearcat 440 95-01; Cheetah 440 -94; Panther 4000 FC 80-81; Trail Cat 4000 FC 80-81; Jag 4000 FC 1980-81					
Jag 440 Z 91-96; Panther DeLuxe 440 84-01; Z 440 ES 90-01; Super Jag 91-92; Jag 440 DeLuxe 88-99; Jag AFS LT					
09-685	60,00	339 2-syl	710-032	09-55113	35-525
Panther, Puma, Cheetah, Pantera 1971-1975 Lynx II -74Jag 340 -75					
09-692	60,00	339 2-syl	710-063B	09-55110	35-502
Bearcat 340 -95-01; Cheetah 340 -94; Jag 340 76-77, 87-90; Jag 3000 FA, FC 78-80; Jag Deluxe 1987-90					
Trail Cat 3000 FC 1980; Manx, Manx Deluxe 1991-93; Manx Mountain Cat 1992-93; Puma DeLuxe 1994-97					

Skidoo, Lynx	Bore	Engine	Gasket set	Oil seals	Needle
09-778	82,00	793 HO, SDI	710-302	09-55229	35-507
Skidoo, Lynx 800 HO, SDI mallit 2000-2007					
09-782	70,50	809 3-syl	710-221 1997-2003	09-55181	35-505
Formula 700, Legend 700, MXZ 700 Summit 700 2000-2002					
09-780	69,50	779 3-syl	710-222 3-syl	09-55181	35-505
09-780-02	70,00	500 2 syl	710-212 2-syl	09-55190	35-505
MM: Mach Z 780 1993-97; MXZ 500 98-Scandic WT LC 1999-00; Summit 500 1996-99;					
09-783	78,00	700 2-syl	710-255	09-55217	35-507
Formula 700, Legend 700, MXZ 700 Summit 700, 2000-02, Enduro 700 2001-02, Enduro 700 RER 2002					
09-781	70,00	699 3-syl	710-222	09-55181	35-503
Rotax 700; F 3 700 1998-00; GT 700 1998-00; GT SE 1997-98; Mach 1 700 1997-00					
09-773	78,00	669 2-syl	710-197 1993-94	09-55105	35-524
09-773-01			710-293 1995-95	09-55190	35-524
09-773-02			710-215 1996-00	09-55190	35-524
09-773-04					
Rotax 670; Mach 1 X 1993; Mach 1 1993-96; MXZ 670 1996-99; GT SE 1994-96;					
09-776	72,00	600 E-Tek, Sdi	710-303	09-55230	35-507
Rotax 600 HO RER, 600 E-Tec, 600 SDI					
09-785	76,00	597 2-syl	710-259	09-55205 -02	35-507
09-785-02				09-55215 03-	
MM: Lynx 600 L/C makes; Formula 600 1999-01; MXZ 600 1999-02; Scandik 600 WT L/C 2001-02					
09-774	64,50	600 3-syl	710-213	09-55181	35-524
Formula III 600 1995-97					
09-772	76,00	582 2-syl	710-178B 1988-92	09-55105	35-505
09-772-01		582 2-syl	710-194 1993-96	09-55105	
09-772-02		583 2-syl	710-178C 1993-96	09-55105	
09-772-04		583 2-syl	710-214 1997-99	09-55105	
		617 2-syl	710-178B Mach 1	09-55105	35-505
MM: Formula Plus, E, XTC,X 1992-93; F Plus EFI 1993-94; Summit 1994-96; Lynx makes 582-583 engine					
09-762 left	69,50	635 2-syl	710-022X	09-55125	35-505
09-762-02					
09-762-04					
09-763 right	69,50	635 2-syl	710-022X	09-55125	35-505
09-763-02					
09-763-04					
Alpine 640 1969-82; Nordic 640 1970-74; TNT 640 1971-72; Valmont 1971-72					
09-779	76,00	550 F/C	710-277	09-55215	35-524
09-779-01					
09-779-02					
09-779-04					
Rotax 550 F/C all, Skidoo, Lynx					
09-761	69,50	436 2-syl	710-025 1971-76	09-55128	35-505
09-761-01		467 2-syl	710-165C 1990-91	09-55105	35-505
09-761-02		467 2-syl	710-165E 1992-93	09-55105	35-505
09-761-04		467 2-syl	710-203 1994-95	09-55105	35-505
MM.Rotax 444, 467; Elite 450 LC 1978-79; Everest 444 LC 1978-79; Everest 464 LC 1980-83; SS-25 1984					
09-740	69,00	247 F/C 1-syl		09-118	35-505
09-740-02		250 F/C 1-syl			35-505
Spirit 250 1979-83; Elan 250 1979-96; Spirit 250 1976-78; Elan 250 E 1971-78					

Skidoo, Lynx	Bore	Engine	Gasket set	Oil seals	Needle
09-741	72,00	503 F/C	710-162 1979-90	09-55103	35-505
09-741-01			710-162 1991-94	09-55104	
09-741-02			710-196 1995-03	09-55104	
09-741-04		532 L/C	710-169	09-55103	
09-741-06		537 L/C	710-177 1989-91	09-55105	
Rotax 503,521,536 Lynx, Nordik, Ockelbo, Skidoo, Trapper, Winha,					
09-741	72,00	253 F/C	710-164 1985-	09-55102	35-505
		277 F/C	710-195 1993-2009	09-55154	35-505
Lynx 250, Citation, Tundra, Tundra II, Freestyle, Scandik Tundra, GL 2300,					
09-752	67,50	447 F/C	710-162C 1984-90	09-55103	35-505
09-752-01			710-162C 1990-91	09-55104	35-505
09-752-02			710-210 1996-07	09-55104	35-505
09-752-04					
Forest Fox; Ockelbo, Skidoo, Trapper, Scandic 440 LT 2001-07, MXZ 440 1999-01, TOUR. E 1999-					
09-751	62,00	377 F/C	710-023A 1980-89	09-55103	35-505
09-751-01			710-023C 1990-94	09-55104	
09-751-02			710-210 1995-2006	09-55104	
09-751-04					
09-751-06					
Rotax 377 ; Lynx, Nordik, Ockelbo, Skidoo, Trapper, Winha					
09-760	67,50	436,6 F/C	710-163C	09-55101	35-505
09-760-01					
09-760-02					
09-760-04					
Blizzard 9500 1979-82; Ultra Sonic 1980-82					
09-759 right	67,50	436,6 F/C	710-025	09-55128	
09-759-02					
09-758 left	67,50				
09-758-02		436,6 F/C			
Everest 440 FC 1974-79; TNT 440 FC 1975-78; Olympic 1977; Futura 440 1975-79; Nuvik 440 1977					
09-750	59,50	339 F/C	N/A	09-165, 09-167	35-505
Blizzard 6500 Plus, 7500 Plus, Cross Country 1978-81; Super Sonic 1979-81					
09-748	59,50	339 F/C 2-syl	N/A	09-167	35-505
09-748-02					
09-748-04					
09-747	59,59	339 F/C 2-syl	N/A	09-167	35-505
09-747-02					
09-747-04					
TNT 340, 1972-76; Olympic 340, E 1975-79; Everest 340, E 1977-79; Futura 340 1975; Nuvik 340, E 76-79					
09-746	78,00	335 F/C 1-syl	N/A	09-118	35-505
09-746-02					
Olympic 335 1969-72; Skandic 1970-73					
09-745	54,00	247 F/C 2-syl	710-119	09-118	35-514
09-745-02					
Elan 250 1973-79					
09-742	76,00	319 F/C 1-syl	N/A	09-118	35-505
09-742-02					
Olympic 320, 320E 1969; Olympic 300, S, M, 1971-77					

Polaris	Bore	Engine	Gasket set	Oil seals	Needle
09-730	85,00	800 2-syl	710-252	09-55193	35-526
Indy 800 XC SP 2001-05, 800 SKS 2003, 800 Classic 2004, 800 LE 2001, 800 Pro X 2003-04, 800 Edge 04					
09-718	66,50	679 3-syl	710-206	09-55186	35-503
Indy Ultra SP, Ultra SPX, SE, Ultra Touring 1996-97					
09-719	72,00	794 3-syl	Internet	09-55177	35-503
Indy Storm 800 1994-98					
09-728	77,25	600 2-syl	710-251	09-55194	
Indy 600 Classic, Touring 2001, Indy 600 Touring 2000, 600 XC SP, Edge 2000, 600 XC SP 2001					
09-716	65,00	567 3-syl	710-204 1994-96	09-55107	
09-716-01			710-205 1997-		
09-716-02					
Indy XLT 600 1995-98; XLT SP 1997-98; Indy XCR 600 1995-97; XC 600 1997					
09-713	67,75	648 3-syl	710-181A		
09-713-01			Indy, Indy SKS	09-55107 88-92	
09-713-02			Indy RXL, SKS, EFI	09-55108 90-97	
09-713-04					
Indy 650, SKS 1988-93; Indy 650, RXL, SKS, 1990-97					
09-714	64,00	580 3-syl	710-191 1992-94	09-55107	35-525
09-714-01			710-204 1994		
09-714-02					
09-714-04					
Indy 580 XLT, SKS, XLT SP 1993-94					
09-707	65,00	398 2-syl	710-109C	09-55107	
09-707-02		597 3-syl	710-175		
09-707-04					
Indy 400 1984-1991; Indy 600 1984-87					
09-720	70,50	500 2-syl	710-237 1999-01	09-55194	35-507
09-720-02			710-250 2002-		
RMK 500, SKS 2000-02, 500 XC1999-02, Indy500 99, Indy 500 XC SP 1999-07, Indy 500 2001					
09-727	73,00	550 F/C	710-238 1998-2003	09-55196	35-503
09-727-01			710-286 1994-	09-55218	
09-727-02					
09-727-04					
Indy 550 Classic, Sport Touring, Supersport 1999-2006, Pro X Fan					
09-711	72,00	488 L/C	710-185A 1989-95	09-55107	35-503
09-711-01			710-208 1996-99	09-55107	
09-711-02		(500) L/C	710-253 2000-2012	09-55187	
09-711-04					
Indy 500 LC, Classic 1989-00; Indy 500, SKS, SP, 1990-98; Indy 500 EFI 1992-98; Widetrack 1997-2012					
09-712 (= 711)	72,00	488 F/C	710-109C	09-55107	35-503
Indy Trail FC 1986; Super Sport 1997-98; Supertrac 1991-93; Indy Trail, Touring 1994-99					
09-710	67,75	440 2-syl	710-186	09-55107	35-503
09-710-02					
09-710-04					
Indy Sport 1991-98; Sport GT 1991-93; Sport Touring 1995-98; Super Sport 1995-96; Transport 1996-98					
09-715	67,72	440 2-syl	Internet	Internet	35-505
09-715-01					
09-715-02					
Indy Lite, DeLuxe; Indy Lite Gt 1994-98; Indy Lite Touring 1998					

Polaris	Bore	Engine	Gasket set	Oil seals	Needle
09-717	62,30	340 2-syl	710-173	09-55107	35-525
09-717-01					
09-717-02					
09-717-04					
Indy Lite, DeLuxe; Indy Lite Gt 1994-98; Indy Lite Touring 1998					
09-709	62,25	339 2-syl	710-173	09-55107	35-525
09-709-01					
09-709-02					
09-709-04					
Sprint ES 1986-90; Indy Sport, GT 1987-90; Indy Lite, GT, Starlite 1991-93					
09-708	61,78	333 2-syl	710-073	09-55107	35-513
09-708-02					
Colt SS 340 1977; Cobra 340 1978-79; SS 340 1979; Apollo, Galaxy, Cutlass 340 1979-1981					
09-706-02	62,50	336 2-syl	710-075A	09-55130	35-513
Starfire 340. 1976, TX 340 F/A 1973-82					
09-705	67,75	440 2-syl	710-079	09-140 x 2	35-520
TX 440 1976-80					
09-704	67,72	432 2-syl	710-078	09-55107	35-520
09-704-02					
TX-C 440C 1981; Long Track 1983-86; Sport, Super Sport SS 1983; TX 440 1973; Cobra 440 1978-79;					
09-703	53,40	250 1-syl	710-069	09-55130	35-520
Starfire 250 1976; TX 250 1976-79					
09-702	53,50	250 1-syl	710-069	09-55130	35-520
Colt 250 1976-78					
09-700	72,00	244 1-syl	710-069	09-55130	35-520
09-700-02		488 2-syl		09-55107	35-520
Electra 250 1975-77; Gemini 244 1979-83; Star 1983-90; Startrak 1987-90; Starlite Gt 1991-95					
Kohler					
09-670-02	62,50	340 2-syl		09-104, 09-113	35-513
09-670-04					
Lynx, Winha mm					
Sachs					
09-SM127	67,40	440 2-syl		09-116, 09-127	
Lynx , Winha mm					
09-801	72,96	290 1-syl			
09-801-01		Huom. mäntä on n. 1 mm matalampi ja helmat n. 2 mm lyhemmät			
09-801-02		Note: piston 1 mm lower, shirt 2 mm shorter, ok to use			
09-801-04					
Lynx, Ockelbo, Winha					
Kawasaki					
09-689	68,00	440 2-syl		09-14603 x 2	35-522
Kawasaki 440 Kawasaki Intriguer, Intruder, Invader; Drifter 440 1978-81					
09-685	60,00	339 2-syl		09-14603 x 2	35-525
Invader 340 F/C 1978-80, Inviter 340 F/C 1978, Drifter F/C 1979-81					

Rotax 503-253

10-741-00
10-741-01
10-741-02
10-741-04

Segment

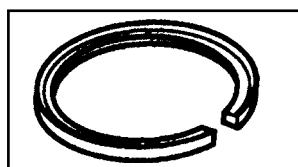

58

Rotax 377

10-751-00
10-751-01
10-751-02
10-751-04

Axe de piston

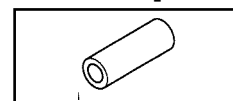







































11-741
11-751

Yamaha	Bore	Engine	Gasket set	Oil seals	Needle
09-826	74,80	598 2-syl	710-201	09-55188	35-521
09-826-02					
V-Max 600, LE, DX, ST, 1994-96					
09-817	73,00	569 2-syl	710-171	09-55170	35-521
09-817-02					
09-817-04					
Exciter 570, 1987-90 Exciter 2, 1991-92					
09-816	73,00	535 2-syl	710-140A	09-55169	35-521
VMX 540 1983-91					
09-808	73,00	535 2-syl	710-167 1979-90	09-55133	35-521
09-808-01			710-182 VK540 1988-2005; 09-55133		35-521
09-808-02					
09-808-04					
EC 540 1979-84 SR 540 1980-91 XL 540 1985-90 VK 540 1988-00					
09-825	68,00	493 2-syl	710-200	09-55188	35-521
V-Max 500 LE, DX, ST, 1994-96					
09-813	72,00	485 2-syl	Internet	Internet	35-505
09-813-01					
09-813-02					
09-813-04					
PZ 480 84-98 480 ST 91-98 VT 480 91-97 VT 480 GT 93-99 VT 480 TF/X 93-00; Venture 500 1999-06					
09-806	68,00	433 2-syl	710-146	09-55131	35-505
09-806-01					
09-806-02					
09-806-04					
GP; TL, 433 1975 EX 440 1976-81 GP 440 1976-78 PR 440 1976-77 STX 1976-77					
09-807	66,00	440 2-syl	710-147C	09-55133	35-505
09-807-02					
SS 440 1980-83					
09-814	68,00	433 2-syl		09-137, 09-143	35-505
09-814-02					
09-814-04					
SR 433, GPX 433 1971-75					
09-815	60,00	338 2-syl		09-137, 09-143	35-505
09-815-01					
09-815-02					
GPX 338 F/A 1974-75					
09-804	60,00	338 2-syl	710-141	09-137, 09-143	35-505
09-804-02					
EX 340 1976-78 STX 340 1976-1977					
09-803	60,00	338 2-syl	710-100	09-55133	35-505
09-803-04					
GP 338 1973 SL 338 1974 GS 338, 340 1976-1979					
09-802	60,00	337 2-cyl	710-142	09-131, 09-132	35-522
09-802-01					
09-802-02					
09-802-04					
EC 340 1982-88 ET 340 1978-88 CS 340 1989-00					









Yamaha	Bore	Engine	Gasket set	Oil seals	Needle
09-800	70,00	246 1-syl	710-027	09-131, 09-132	35-505
09-800-01					
09-800-02					
Br 250 1982-94 Br 250T, TS 1985-00; BR 250 TS 1984-97					
09-801	72,96	246 1-syl	710-138	09-131, 09-132	35-505
09-801-01					
09-801-02					
09-801-04					
ET 250 1977-81					
09-812	73,00	292 1-syl			35-505
09-812-01					
GP 292 1972-73 SM 292 1973-74					
09-811	56,00	292 2-syl	710-138B	09-135, 09-143	35-505
09-811-02					
ET 300 1980-84					
09-810-02	73,50	292 1-syl			35-505
SL 292 1971-72					

Exhaust gaskets

718-057 Arctic Cat	718-059 Arctic Cat	718-024 Rotax	718-163 Rotax
			
340 F/C	370,440,500,600	377, 447 F/C	503, 550 F/C
718-177 Rotax	718-178 Rotax	718-185 Rotax	718-192 Rotax
			
582, 58 L/C	700,800,440,583	600 L/C	500 L/C
718-164 Polaris	718-071 Polaris	718-109 Polaris	718-184 Polaris
			
600, 700 U.S.	340,440,448	LC Fuji, 340 F/C	440 L/C
718-186 Polaris	718-187 Polaris	718-190 Polaris	718-028 Yamaha
			
440,544 F/C	500,660 U.S	440,700,800 U.S	Almost all

Arctic Cat	Arctic Cat	Arctic Cat	Arctic Cat
05-15225 pair	05-15232 pair	05-15240 pair	05-15241 pc
0109-932	0115-603	0702-264	0702-229
			
Arctic Cat	Polaris	Polaris	Polaris
05-15244 pair	05-15214 pc	05-15231 pc	05-15237 pc
0702-563 v. 2006-	1930 723	1930 588	1930 586
			
Polaris	Polaris	Polaris, 2201430,	Polaris
05-15243 paire	05-15255 paire	05-15251 paire	05-15254 paire
1930 723	220 1567, 2001-		2003-2011 IQ, Indys
			
Polaris	Polaris, 220 1429	Skidoo, Lynx	Skidoo
05-15203 paire	05-15252 paire	05-15235 paire	05-15247 paire
193034 7/5		Nordik	860.701.700
			
Skidoo, Lynx	Skidoo, Lynx	Skidoo, Lynx	Skidoo, Lynx
05-15212 paire	05-15242 paire	05-15246 paire	05-252FM, paire
860.701.400	860.700.700	414.990.900	507-032-473
			
Lynx		Lynx	
85-184 pc		85-183 Lynx 5900	Lynx 85-162
1986-1993		Lynx 535, 3900, 650	Lynx 535, 3900, 650
			

Ensemble d'accessoires de frein

Yamaha 05-15224 paire	Yamaha 05-15249, 05-15250	Yamaha 05-15226 pc	Yamaha 05-15228 pc
			
Yamaha	05-15245 kpl	Yamaha 05-451FM	Yamaha 05-450FM
			pas d'image Vector, Phazer 2006-
Ockelbo 85-179	15-00 Velsa ressort d'embrayage	37-08 Ockelbo ressort en caoutchouc	
			

Attaches cabine (caoutchouc)

Aktiv 12-131	Lynx, Yamaha 12-13402	Polaris 12-135
		
Polaris 12-13501	Arctic Cat 12-130	Skidoo 12-132
		

Skidoo 12-261

Skidoo 12-260

12-165 Rétroviseur



00-601

Décalcomanies

00-600



Démarrreur

Pour; OEM P/N

01-0192	 <p>DG-0058-1 9-tooth Drive gear</p> 	<p>CB-0092-10 Brush holder Assembly</p> 	<p>Polaris: 417 0006, 241 0748</p>
01-0201	 <p>DG-0058-1 9-tooth Drive gear</p> 	<p>CB-0092 Brush holder Assembly</p> 	<p>Arctic Cat: 0745-018, 0745-030, 0745-052, 0745-257 0745-357 1991-2007</p>
01-0202		<p>CB-0092-1 Brush holder Assembly</p> 	<p>Arctic Cat: 0645-183 0654-312, 0645-578 1995-2002</p>
01-0203		<p>CB-0092-10 Brush holder Assembly</p> 	<p>Arctic Cat: 0745-143 0745-126, 0745-356 2001-2007</p>
01-0204	 <p>DG-0091-1 8-tooth Drive gear</p> 	<p>CB-0210 Brush holder Assembly</p> 	<p>BRP: 515-176-003 515-176-113, 515-175-562 515-175-843 2000-2007</p>
01-0205	 <p>BRP: 410-212-400</p>		
01-0206	 <p>DG-0092-1 9-tooth Drive gear</p> 	<p>CB-0063 Brush holder assembly</p> 	<p>Yamaha: 8BB- 81800-01-00 8BB- 81800-00-00 8Y3- 81800-51-00 1988-2005</p>
01-0207	 <p>DG-0093-1 9-tooth Drive gear</p> 	<p>CB-0140-1 Brush holder Assembly</p> 	<p>Yamaha: 8CW-81800-00-00 8CW-81800-01-00 1997-2003</p>
01-0228	 <p>DG-0095-1 9-tooth Drive gear</p> 	<p>CB-0140-1 Brush holder Assembly</p> 	<p>Kubota: Kubota: 70000-65440 Denso: 228000-6910 Denso: 228000-6911</p>
01-0229	 <p>DG-0095-1 9-tooth Drive gear</p> 	<p>CB-0140-1 Brush holder Assembly</p> 	<p>BRP: 410-207-500 Lynx, Skandic Rotax 494 1997-2000</p>

Boîte électronique



01-14342
Rotax 410.918.900



01-14343
Rotax 420.965.591



01-401
Arctic Cat 3004-099



01-14340
Rotax 420.866.595



01-415
Yamaha 8V0.85540.21



01-407
Polaris 3083725



01-14345
Rotax 420.965.757



01-40701
Polaris 3083989



01-40801
Polaris 3084007



01-14329
Arctic Cat 3003-777



01-14372
Skidoo 512.058.927 Form.

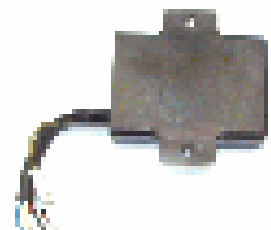

01-406
Pol. 3083721 600-650



01-404
Polaris 308 3723



01-14327
Arctic Cat

Bobine d'allumage



01-14332
Bosch, Skidoo, Motoski

Bobine d'allumage



01-14310
Rotax 410.916.000



01-14311
Rotax 410.913.500 Arctic



01-14319



01-14312
Arctic Cat 3003-221



01-14313
Polaris 3082974



01-143120
Arctic Cat 3003-977



01-14314
Yamaha 8W3.82310.10



01-14315
Yamaha 8E7.82310.10



01-14317
Yamaha 5.82310.40



01-14351
Yamaha 8AB.82310.10



01-14353
Arctic Cat 3003-575



01-14355
Rotax 10.920.500



01-14350
Yamaha Bravo 250 -88



01-14363
AC 3005-381 ZL-ZR 5-700



01-14371
Rotax 420.996.705
Form. III, Mach1, Z, ZR

Bobine d'allumage



01-14360
Arctic Cat 3004-126



01-14361
Arctic Cat 3004-483



01-14362
Polaris 3084469

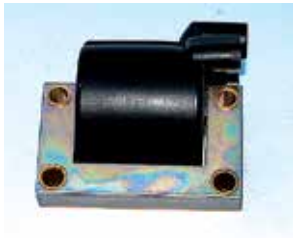

01-1430
Rotax, Bosch, Arctic Cat



01-14367
Polaris 3085293



01-14370
Formula 415.085.400

Interrupteur d'urgence



01-113 Arctic Cat



01-11120
Skidoo

01-11121
Skidoo 515.1515.00



01-11113
Yamaha, Arctic Cat, Polaris



01-112

Bougie



BOSCH

05-B8
05-B9

Type de résistance BR8ES
Type de résistance BR9ES



01-120
Universal, oldies
Push-stop-model

Régulateur de tension

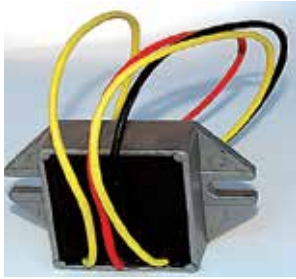

01-15416 3 wires
01-15416B 4 wires



01-15402
Rotax 410.908.900



01-15406
Rotax, Arctic Cat



01-15421
Polaris 4060122



01-15417 250 W
Rotax



01-15415
Rotax 410.908.900



01-15436
Yamaha 98A.81910.00



01-15418
Arctic Cat



01-15426
Arctic Cat 0232-014



01-15432
Yamaha 82F.81910.

Capuchon de bougie



01-15435
Yamaha 82M.81910.AO



01-110



01-1101



01-100 Chargeur 12 V

RIPSAW FULL

Model
9002U



Model 2,52"	Dimension cm	Lug h. mm	Weight kg
9002	50 x 396	32,0	31,0
9151	50 x 396	32,0	31,0

Model 2,86"	Dimension cm	Lug h. mm	Weight kg
9089	50 x 391	35,0	30,0

ICE WIDE TRACK

Model
9008U



Model 2,52"	Dimension cm	Lug h. mm	Weight kg
9008	50 x 396	32,0	33,0



NEW COBRA WT New COBRA WT600

UTILITY

Model
9195U



Model 2,52"	Dimension cm	Lug h. mm	Weight kg
9195	50 x 392	46,0	29,0
9196	50 x 392	38,0	28,0

Model 2,52"	Dimension cm	Lug h. mm	Weight kg
9260	60 x 392	46,0	
9261	60 x 392	38,0	



Model
9793H144

ENERGY



TRAILS

Model 2,52"	Dimension cm	Lug h. mm	Weight kg
9793	38 x 307	25,0	15,0
9794	38 x 345	25,0	16,0

HACKSAW



Model 2,52"	Dimension cm	Lug h. mm	Weight kg
9147	38 x 307	25,0	15,0
9960	34 x 325	25,0	15,0

TRAILS

NEW ICE ATTACK XT



Model 2,52"	Dimension cm	Lug h. mm	Weight kg
9200	38 x 307	31,0	18,0
9201	38 x 325	31,0	19,0
9202	38 x 345	31,0	20,0
9203	38 x 365	31,0	21,0

Model 2,86"	Dimension cm	Lug h. mm	Weight kg
9190	38 x 307	31,0	18,0
9236	38 x 325	31,0	19,0
9191	38 x 345	31,0	20,0

ICE RIPPER XT



Model 2,52"	Dimension cm	Lug h. mm	Weight kg
9077	38 x 307	31,0	18,0
9078	38 x 325	31,0	19,0
9079	38 x 345	31,0	20,0
9173	38 x 365	31,0	21,0

Model 2,86"	Dimension cm	Lug h. mm	Weight kg
9164	38 x 307	31,0	16,0

COBRA

TRAILS

Model
9052H



Model 2,52"	Dimension cm	Lug h. mm	Weight kg
9052	38 x 307	34,0	17,0
9081	38 x 325	34,0	18,0
9061	38 x 345	34,0	19,0
9107	38 x 366	34,0	20,0

Model 2,86"	Dimension cm	Lug h. mm	Weight kg
9092	38 x 305	34,0	15,0
9235	38 x 327	34,0	16,0
9093	38 x 348	34,0	17,0
9094	38 x 371	34,0	18,0
9114	41 x 348	34,0	18,0

COBRA 1,6



Model 2,86"	Dimension cm	Lug h. mm	Weight kg
9262	38 x 305	41,0	17,0
9263	38 x 327	41,0	18,0
9264	38 x 348	41,0	19,0
9265	41 x 348	41,0	20,0

ICE COBRA 1,6

Model 2,86"	Dimension cm	Lug h. mm	Weight kg
9244	38 x 305	41,0	17,0
9245	38 x 327	41,0	18,0
9246	38 x 348	41,0	19,0
9249	41 x 348	41,0	20,0



NEW ICE Cobra 1.6

**Our Denis Courtemanche
Special Edition**

This recently launched Cobra track featuring ICE Technology has been named the "Denis Courtemanche Special Edition," in honor of the longtime Camoplast recreational products director and former Bombardier employee who has devoted 50 years to improving snowmobile track design.

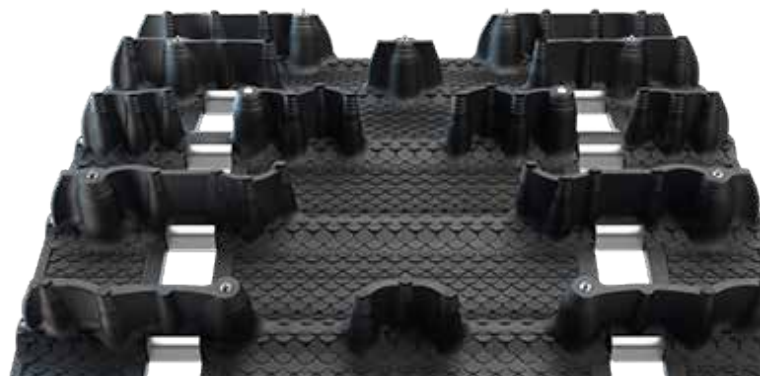

NEW RIPSAW II

Model
9156H



RIPSAW

Mallit
9968H144 &
9969H162
TRACKtion
Control™



RIPSAW 1.5

Model
9112C



Model 2,52"	Dimension cm	Lug h. mm	Weight kg
9214	38 x 307	32,0	19,0
9215	38 x 325	32,0	20,0
9216	38 x 345	32,0	21,0

Model 2,86"	Dimension cm	Lug h. mm	Weight kg
9158	38 x 305	25,0	15,0
9224	38 x 348	25,0	17,0
9156	38 x 305	32,0	16,0
9223	38 x 348	32,0	19,0
9237	38 x 326	32,0	18,0
9209	38 x 305	32,0	17,0
9210	38 x 305	25,0	15,0

TRAILS

Model 2,52"	Dimension cm	Lug h. mm	Weight kg
9001	34 x 325	32,0	15,0
9146	38 x 307	32,0	16,0
9040	38 x 325	32,0	19,0
9968	38 x 307	32,0	17,0
9969	38 x 348	32,0	20,0

Model 2,86"	Dimension cm	Lug h. mm	Weight kg
9148	38 x 305	25,0	15,0
9149	38 x 305	32,0	16,0

Model 2,52"	Dimension cm	Lug h. mm	Weight kg
9045	34 x 325	38,0	18,0
9112	38 x 307	38,0	19,0

9045 track = Every 3rd / open windows

Model 2,86"	Dimension cm	Lug h. mm	Weight kg
9159	38 x 305	38,0	17,0
9238	38 x 326	38,0	18,0

SOKOSTI

Model
9003C



TRAILS

Model 2,52"	Dimension cm	Lug h. mm	Weight kg
9003	38 x 366	38,0	23,0
9004	38 x 384	38,0	24,0
9005	38 x 404	38,0	22,0

INTENSE



Model 2,52"	Dimension cm	Lug h. mm	Weight kg
9930	38 x 307	38,0	18,0
9108	38 x 345	38,0	19,0

FREERIDE

Model
9033C



Model 2,52"	Dimension cm	Lug h. mm	Weight kg
9033	36 x 307	38,0	17,0
9034	36 x 345	38,0	18,0
9044	36 x 365	38,0	19,0

SNO X

Models
9169R &
9189R



RACING

Model 2,52"	Dimension cm	Lug h. mm	Weight kg
9067	38 x 307	44,0	19,0
9068	38 x 325	44,0	20,0

Model 2,86"	Dimension cm	Lug h. mm	Weight kg
9169	38 x 305	44,0	18,0
9189	38 x 326	44,0	20,0

CHALLENGER TRAIL

CROSS-COUNTRY

Model
9069C



Model	Dimension cm	Lug h. mm	Weight kg
2,52"			
9047	36 x 384	57,0	24,0

Model	Dimension cm	Lug h. mm	Weight kg
2,52"			
9933	41 x 345	44,0	22,0

Model	Dimension cm	Lug h. mm	Weight kg
2,86"			
9069	41 x 305	44,0	18,0
9070	41 x 348	44,0	20,0
9167	41 x 371	44,0	22,0

BACKCOUNTRY

Model
9140C



Model	Dimension cm	Lug h. mm	Weight kg
2,52"			
9140	38 x 307	44,0	18,0
9141	38 x 325	44,0	19,0
9142	38 x 345	44,0	20,0
9143	38 x 366	44,0	21,0

BACKCOUNTRY X

Model
9125C



Model	Dimension cm	Lug h. mm	Weight kg
2,86"			
9287	38 x 305	44,0	18,0
9126	38 x 348	44,0	20,0
9256	38 x 305	51,0	19,0
9257	38 x 327	51,0	20,0
9258	38 x 348	51,0	21,0

Model	Dimension cm	Lug h. mm	Weight kg
3,00"			
9254	38 x 358	44,0	23,0

CHALLENGER EXTREME

MOUNTAIN

Full Clip

Models
9104M &
9105M

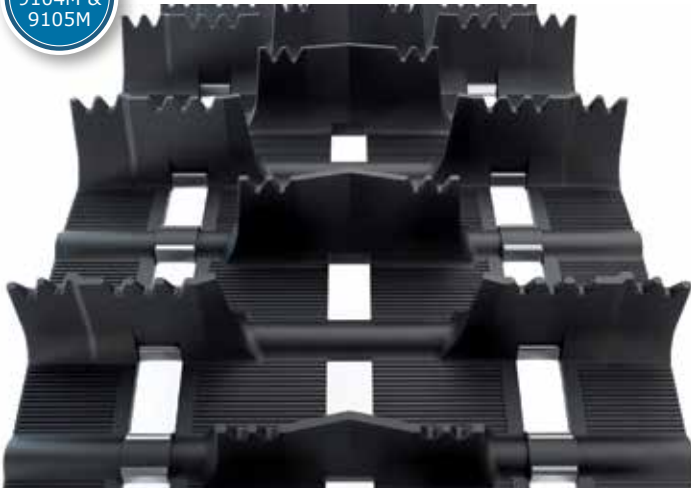

Model 2,86"	Dimension cm	Lug h. mm	Weight kg
9102	41 x 391	64,0	27,0
9103	41 x 414	64,0	28,0
9104	38 x 391	64,0	25,0
9105	38 x 414	64,0	26,0
9144	41 x 371	64,0	25,0
9145	38 x 371	64,0	24,0

Model 3,00"	Dimension cm	Lug h. mm	Weight kg
9035	38 x 442	64,0	29,0
9036	41 x 442	64,0	30,0
9115	41 x 442	76,0	34,0
9225	41 x 396	76,0	31,0
9951	38 x 381	76,0	30,0

CHALLENGER

Full Clip

Models
9174M &
9175M



Model 3,00"	Dimension cm	Lug h. mm	Weight kg
9174	38 x 389	64,0	26,0
9175	38 x 712	64,0	25,0
9175	41 x 712	64,0	26,0

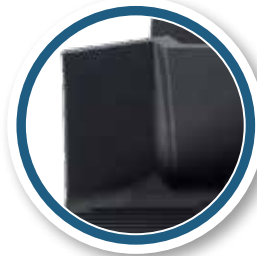

CHALLENGER 3 NEW

Full Clip

Model
9219M



Model 3,00"	Dimension cm	Lug h. mm	Weight kg
9219	41 x 412	76,0	28,0
9220	15 x 412	76,0	26,0
9270	38 x 396	76,0	25,0
9271	38 x 442	76,0	29,0

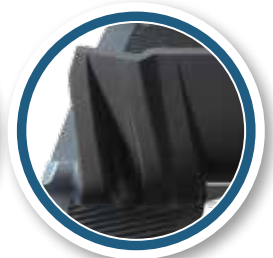

NEW SOFTER LUGS AT THE TIP AND STIFF BASE FOR POWDER SNOW TYPES

Models
9230 &



Model 2,86"	Dimension cm	Lug h. mm	Weight kg
9179	41 x 371	64,0	25,0
9230	38 x 392	64,0	25,0
9231	38 x 414	64,0	27,0
9232	41 x 392	64,0	27,0
9233	41 x 414	64,0	29,0

PEAK 2.5

MOUNTAIN

CHALLENGER

Model 2,52"	Dimension cm	Lug h. mm	Weight kg
9797	38 x 345	51,0	23,0
9798	38 x 307	51,0	20,0
9875	38 x 366	51,0	23,0
9876	38 x 384	51,0	24,0
9884	38 x 403	51,0	25,0
9047	36 x 384	57,0	21,0

Model 2,86"	Dimension cm	Lug h. mm	Weight kg
9064	41 x 371	59,0	22,0
9065	41 x 391	59,0	24,0
9186	41 x 348	51,0	23,0
9899	41 x 365	51,0	24,0
9187	41 x 371	51,0	22,0
9188	41 x 391	51,0	26,0
9204	41 x 348	59,0	21,0

Model
9064M



Rip Saw profiles

Pitch. 2,52"

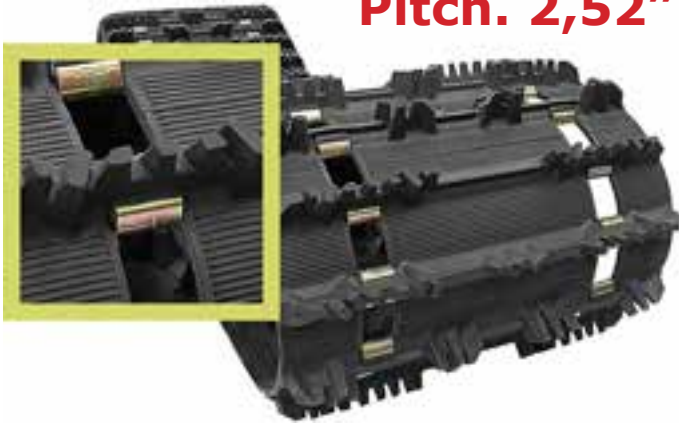

Rip Saw 32 mm			
Number	width	length	cam
	cm	cm	mm
04-9006	38	365	32
04-9007	38	385	32
04-9925	38	403	32
Special width			
04-9021	40,5	345	32

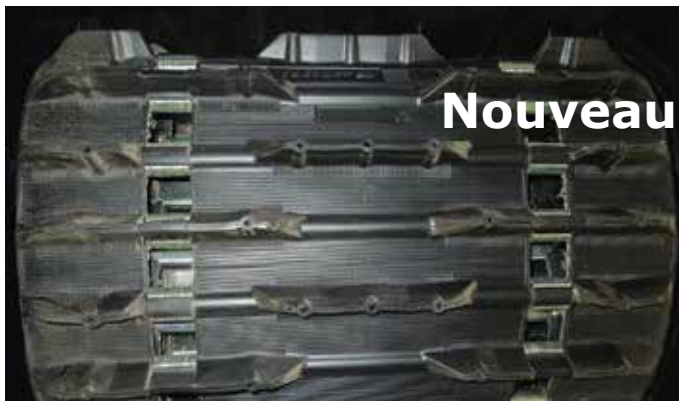

6900-track 31 mm full clip			
Number	width	length	cam
	cm	cm	mm
04-7000	60	397	31
Durasport 25 mm, full clip			
04-9863	38	345	25



Durasport 15 mm full clip			
Number	width	length	cam
	cm	cm	mm
04-9755	38	290	15
wheel boggie			
04-9756	38	290	15
slide suspension			



Explorer 25 mm Full clip			
Number	width	length	cam
	cm	cm	mm
04-9806	38	396	25

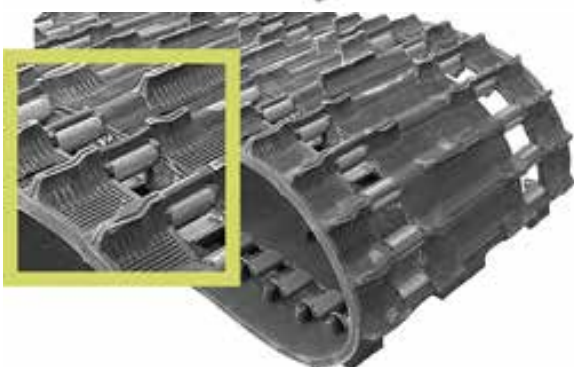

Explorer 19 mm full clip			
Number	width	length	cam
	cm	cm	mm
04-9011	38	353	19

Camoplast a cessé la production nationale de chenille d'origine pour le niveau de la presse. Cela signifie que les marques nationales et la motoneige suédois, comme Lynx, Winha, Trapper, et le Ockelbo, Nordik, laissé sans un chenille de rechange. La dernière tranche de chenilles fabriqués à l'été 2010.

Remplacement du Lynx chenille 5900 et l'extension du temple de l'extension



Déconnecté tube

Souder un morceau de tuyau qui est inséré entre les. Vous obtenez des morceaux de chenille avec

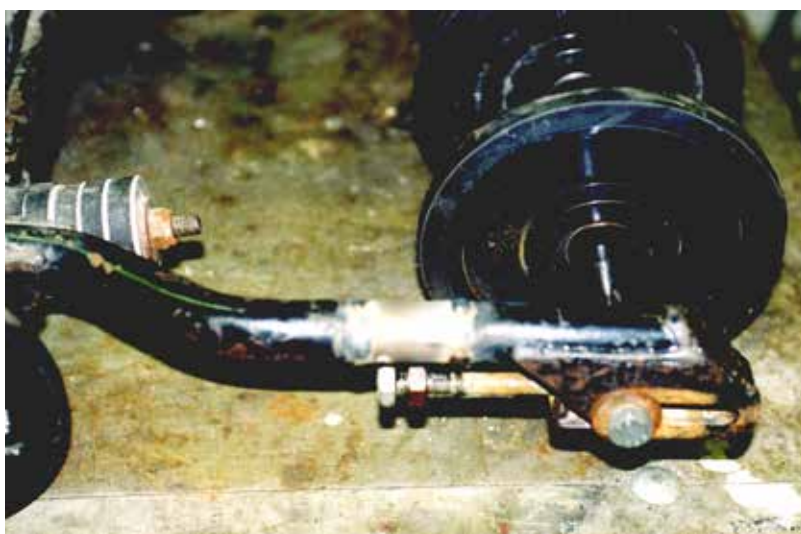

Soudage à la figure achevée. Dans ce modèle, les roues lisses. Peut également se poursuivre si le dos est engrenages. Par exemple, les modèles 250, 3900 est Très souvent, les engrenages. Les barbotins sont également modifiés. Nécessite l'axe hexagonal. Round ne peut pas être jugé apte à vélos

Nous vous recommandons de No-Slip barbotins.

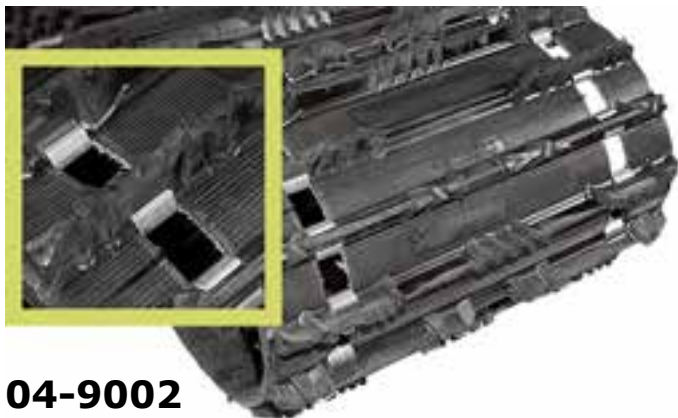

04-9002



Sokosti

04-9005

04-9925 + 04-3000 = 403 cm

04-9925 Predator remplace la chenille 396 cm tel que l'illustration ci dessous. Cette chenille est 7 cm plus longue que l'originale c'est pourquoi vous devez utiliser la roue de support 180 mm sur l'essieu arriere.



384 cm



365 cm



04-3002

chassis 400-410 mm
longueur 200 mm

Profile d'aluminium



04-3001

chassis 400-420 mm
longueur 600 mm

04-3003

chassis 415-430 mm
longueur 600 mm



Agrafes

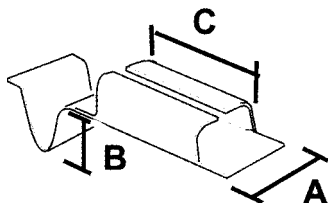

	p/n	A	B	C
38-02	21	-	-	30
38-03	20	-	16	30
38-04	23	-	18	21
38-05	21	-	-	38
38-07	21	-	-	19
38-08	22	-	-	20
38-09	19	14	-	25
38-10	19	-	-	25

38-03



Outil indispensable pour l'installation de segments sur les chenilles Camoplast
Part number: 38-100

Raccourcir / Rallonger

04-3050
universal 12 cm

307cm ---> 325cm
325cm ---> 345cm
345cm ---> 365cm



25mm l'arbre

04-3060
Yamaha 12 cm

307cm ---> 325cm
325cm ---> 345cm
345cm ---> 365cm



20mm l'arbre

04-3080
Yamaha 20 cm

307cm ---> 345cm
325cm ---> 365cm



20mm l'arbre

04-3300
Lynx 20 cm

320cm ---> 345cm
330cm ---> 345cm
Only LYNX!

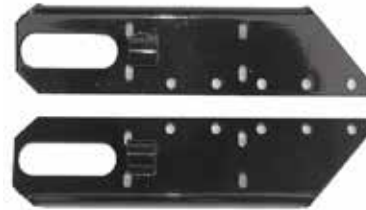

25mm l'arbre

04-3040
universal 25 mm l'arbre
20 cm extending

307cm ---> 345cm
325cm ---> 365cm



25mm l'arbre



25mm l'arbre

04-3070

To shorten Lynx G-type.
320 cm long boggie made
use track 307 cm long

04-3000 / Flip



345cm ---> 384cm
345cm ---> 403cm
365cm ---> 403cm ++
With the flip 30cm more



Flip, instruction

Photos :

Sur cette photo vous voyez une chenille de 384 cm de long

Pour obtenir des résultats optimaux dans l'alignement de vos chenilles, poussez l'arbre le plus loin possible du côté gauche

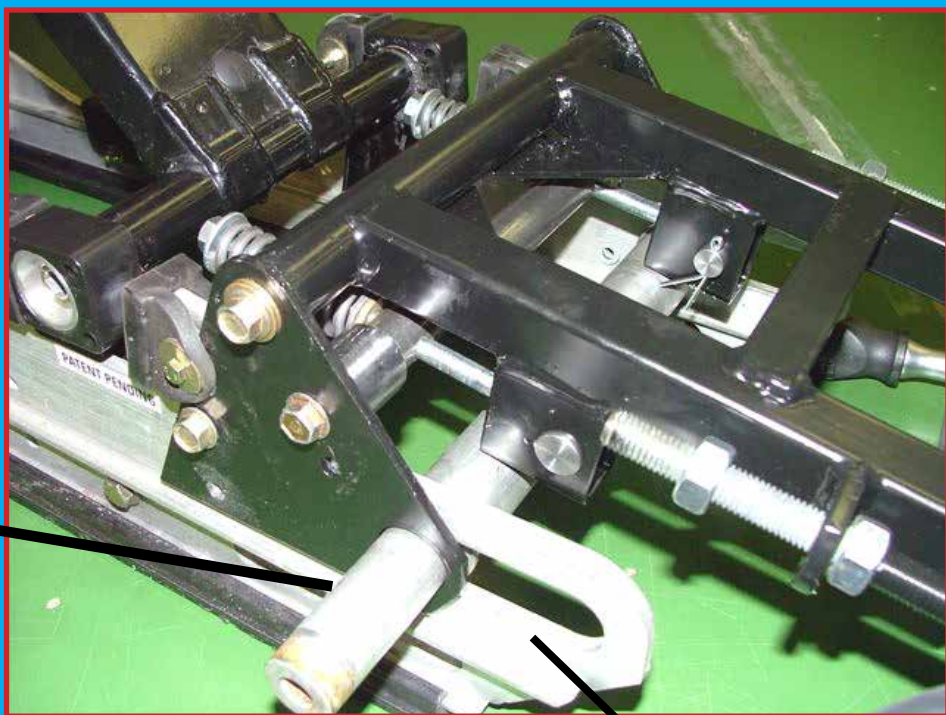

Photos :

Sur cette photo vous voyez une chenille de 403 cm de long

Pour obtenir des résultats optimaux dans l'alignement de vos chenilles, poussez l'arbre le plus loin possible du côté droit

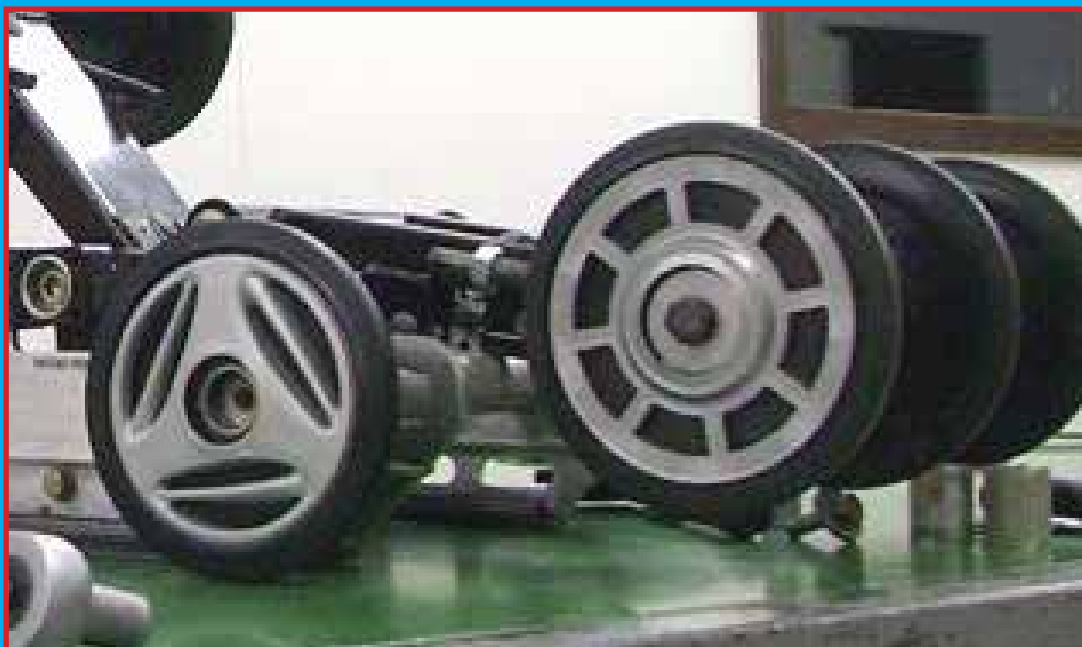

Bonne saison de motoneige !!



384 cm



403 cm

Toutes les motoneiges peuvent être modifiées selon vos goûts. Il n'y a pas de limite ! Cependant, dans certains cas vous devez évaluer si l'effort requis pour modifier votre motoneige en vaut la peine.

La décision vous revient

S'il vous plaît, considérez que dans certain cas, une motoneige d'origine a une plus grande valeur monétaire qu'une motoneige modifiée.



La Famosa Legenda

AO

NOUVEAU SPECTACLE
Tout l'été à Drummondville
astalegenda.com

Note.

Cette page ainsi que plus de 2000 autres peuvent être consultées sur Internet à l'adresse: [www.teolehtimaki.fi/spare parts catalogue](http://www.teolehtimaki.fi/spare_parts_catalogue) and pls, check your make.

Malli: MXZ 583

Vuosi: 1996

Moottori

Rotax 582, 583 1989-99

09-772	mäntä, std
09-772-01	mäntä, 0,25 ylikoko
09-772-02	mäntä, 0,50 ylikoko
09-772-03	mäntä, 0,75 ylikoko
09-772-04	mäntä, 1,00 ylikoko
35-505	männäntäpin laakeri
710-178C	tiivistesarja, tarkista
09-55105	kampiakselin tiivisteet
09-16002	välitiiviste kampiakseli
35-6206 GPC4	kampiakselin laakeri x 3
35-6207 GPC4	kampiakselin laakeri x 2
35-6305 NRC4	kampiakselin laakeri x 1
722-2505	PTO kiertoakanki
722-2505	MGT kiertoakanki

Kuva



Omistaja: **Teo Lehtimäki**, myyty Ruotsiin. Tämän kelkan myyntiä kaduin monta vuotta
Kuvassa **Tommi ja Lotta**

Muut osat / Teo Lehtimäki Oy



30-21	L=140 cm musta
30-621	L=140 cm grafiitti
30-210	L=163 cm musta

Track Camoplast

38 307 / 22

04-9793, 04-9009,
04-9830, 04-9753

Notre page principale est mise à jour régulièrement afin de toujours avoir la plus récente information concernant nos produits

Powerbloc / Teo Lehtimäki Oy

P80-kytkin 15-84 (1002-0009)



Spring: 15-93
Jousi: 15-93
Shims: 9 kpl
Prikat: 9 kpl
Pieni kartio, ei voi asentaa Rotax starttikehää.

3700-3800 r/min, kytkentäkierrosluku
7900-8000 r/min, max. kierrosluku

Vuotsolaiset Suksimuovit Ohjainkiskot Peltisuksi

32-99	Suksimuovi
33-20	CTRL levike 180 mm
MM142	Kovametalli

Muut osat / Teo Lehtimäki Oy

05-B8	sytytystulppa
01-14342	CDI yksikkö
01-15416	tasasuuntaaja, E-mallit
01-15415	jännitteensäädin
01-14355	puola