

Teo Lehtimäki Oy



Svensk utgåva för SVERIGE

2007 2007 2007 2007 2007 2007

Katalog 2007

Uppge alltid tydliga referensnummer. Originalnummer är angivna till ledning och avser således ej originaldelar.

Teo Lehtimäki Oy

Vuopajantie 34 96400 Rovaniemi Finland

Teo Lehtimäki

info@teolehtimaki.fi

mob. +358-400-162110

fax +358-16-366004

vat. FI08350750

Teo Lehtimäki Oy

Kaarronnevantie 54 61800 Kauhajoki Finland

Vesa Peltonen

mob. +358-40-5769111

fax +358-6-2311170

Personliga e-mail adresser

teo@teolehtimaki.fi

vesa@teolehtimaki.fi

artturi@teolehtimaki.fi

Teo Lehtimäki

Vesa Peltonen

Artturi Lehtimäki

Ekonomi

Eeva Lehtimäki

eeva@teolehtimaki.fi

NYHET

Nu kan vi även sälja i Sverige dessa mattor som finns i katalogen. Gäller endast för företagskunder. Privatkunder hänvisas till våra återförsäljare.



Bredd 38 cm

A = 50 mm



Lynx, Winha, Skidoo, Nordik 300, R, 377R

04-3315	38 x 315 cm	B = 63 st
04-3333	38 x 330 cm	B = 66 st
04-3357	38 x 353 cm, Elan	B = 70 st
04-3392	38 x 392 cm	B = 78 st

Ockelbo

04-3372
04-3375
04-3377
04-3386

Lynx 320 och 330 modeller

38 x 372 cm	B = 74 st
38 x 375 cm	B = 75 st
38 x 385 cm	B = 77 st
38 x 385 cm	B = 77 st

Om måttet **A** är 70 mm, med att byta hjul kan mattan monteras



Kuggjul för 27 mm
sexkant-axel



Kuggjul /
Vändhjul



Vändhjul

Bredd 50 cm

A = 50 mm



Lynx

Winha

04-5330

50 x 330 cm

B = 66 st

04-5370

50 x 372 cm

B = 74 st

04-5392

50 x 392 cm

B = 78 st

Om måttet **A** är 70 mm, med att byta hjul kan mattan monteras



Trapper

04-5372

50 x 372 cm

B = 74 st

04-5382

50 x 382 cm

B = 76 st



Nordik (ej hjulbyte)



04-6330 60 x 330 cm B = 66 st
Aktiv Teddy **Bredd 60 cm**



Drivmattor

OBS: Katalogsidan från 2006

Lynx och Winha

produkt	bredd / cm	längd / cm	pinnar / st	notera
04-9755	38	290	58	Elan, Lynx 30 serie
04-3333	38	330	66	Lynx 2300, Lynx 3300
04-3392	38	392	78	Lynx 250, 3900, 360, Ranger
04-5330	50	330	66	Lynx GLX kort, Finlandia
04-5370	50	372	74	Lynx 535 hjulboggi
04-5392	50	392	78	Lynx 5900
04-6340	60	330	67	Lynx 640 Finlandia
04-6372	60	372	74	Lynx 635
04-6380	60	382	76	Lynx 650 glidboggi
04-6390	60	392	78	Lynx 650 XL hjulboggi

Nordik och Trapper (Skidoo)

04-3392	38	392	78	Nordik 300, 377, 377 R
04-5372	50	372	74	Nordik 500, Trapper 500
04-5382	50	382	76	Nordik 540, 550, 500 PSS
04-6372	60	372	74	Trapper 600

Ockelbo

04-3375	38	375	75	Ockelbo 8000
04-3377	38	385	77	Poro okkeli
04-6000	60	325		Ockelbo 600 mellandrift
04-6372	60	372	74	Ockelbo 6000

LYNX, WINHA

OBS: Katalogsidan från 2006

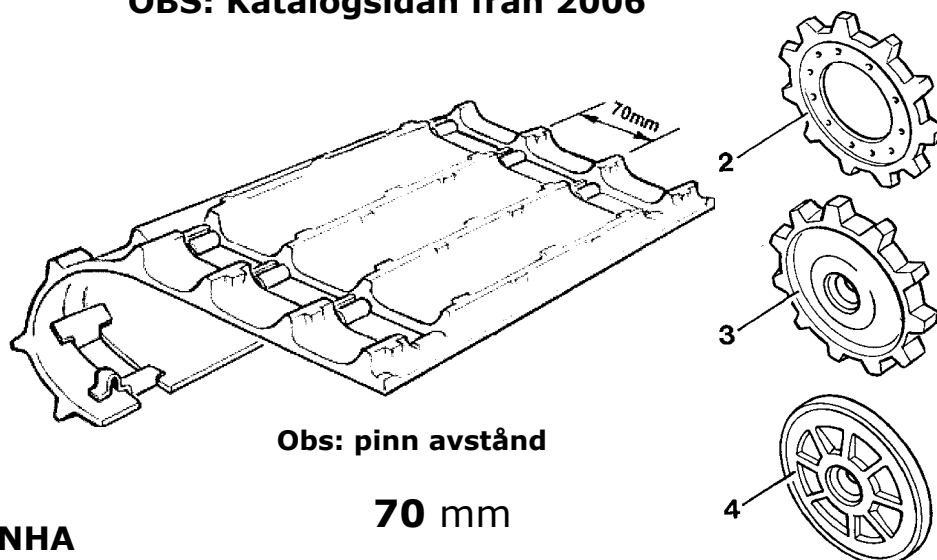

Obs: pinn avstånd

70 mm

LYNX och WINHA

Denna drivmattan tillverkas ej, men den kan ersättas med andra mattor, delning 50 mm (sida 4). Byt drivhjul och bakre kugghjul enligt skissen. Kolla också drivaxeln och bakre kugghjul att dom är hela men byt alltid drivaxelns kullager UC205.

produkt	bredd/ cm	längd/ cm	pinnar nu	pinnar ny	notera
04-3333	38	330	47 st66 st	Lynx 2300, 3300	
04-3392	38	392	56 st78 st	Lynx 250, 3900	
04-5330	50	330	47 st66 st	GLX Finlandia	
04-5370	50	372	54 st74 st	Lynx 535	
04-5392	50	392	56 st78 st	Lynx 5900	

DRIVHJUL

(delning 50 mm)

produkt	bild	bredd mm	axel	kuggar	notera
37-00	2	22	rund	9 st	Lynx, Ockelbo, Skidoo
37-01	2	30	rund	9 st	Trapper; Lynx
37-02	2	30	rund	10 st	Nordik 540, 550, PSS
37-03	2	30	rund	11 st	Lynx
37-04	1	30	hexa	11 st	Lynx

BAKRE KUGGHJUL (fördelning 50 mm)

produkt	bild	bredd	kullager	kuggar	notera
20-5285	3	22	6205	9 kpl	Lynx, Ockelbo
20-5286	3	30	6205	9 kpl	Lynx, Trapper, Nordik, Ockelbo
20-5288	3	30	6205	10 kpl	Nordik 540, 550, PSS
20-5287	3	30	6205	11 kpl	Lynx, Nordik 377R

VÄNDHJUL

Om det redan är monterat runda hjul på bakaxeln, så kanske det inte är nödvändigt att ersätta dom, men glöm inte att kolla kullagren, dom kan behövas bytas.

Bredd 60 cm



04-6340	60 x 340 cm	B = 67 st Lynx Finlandia, Winha 60
04-6372	60 x 372 cm	B = 74 st Lynx 635, Ockelbo 6000, Trapper 6000
04-6380	60 x 382 cm	B = 76 st Lynx 650 S Glidboggi
04-6390	60 x 392 cm	B = 78 st Lynx 6000/650

Ockelbo 600



04-6000 HSB 54

04-6370 60 x 372 cm B = 74 st
Nordik 600 SLE

Bredd 60 cm



Förlängd snöskoter i Ammarnäs





Ski-doo GTX 550 "Pick-up" -05

Använda delar:

Drivmatta 383x40,6cm, 51mm kamhöjd
Förlängning 04-3000 kort variant, 160mm vändhjul
Bandtunnelförlängning 04-3001
Plastskidor Vuotsolainen 23cm

Förstärkningen av bandtunneln

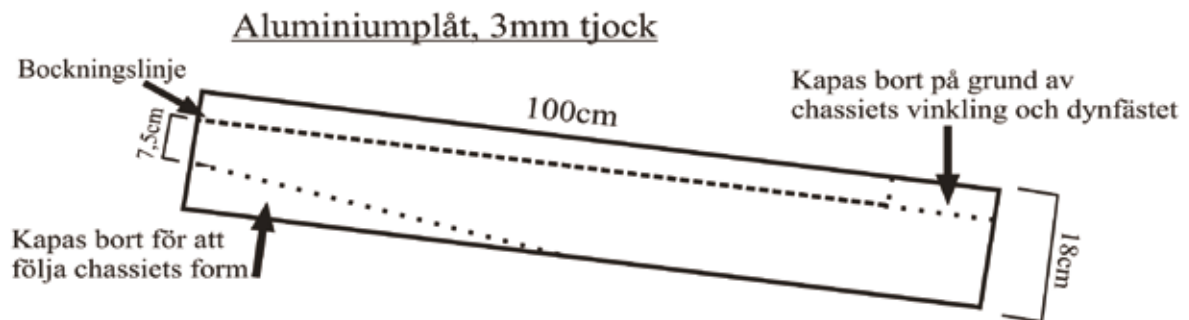

Aluminiumplåten bockas till denna profil (ungefärliga mått):



Aluminiumprofil

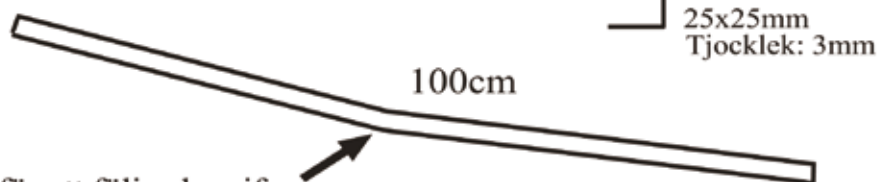

Kort beskrivning:

Lastbågarna är flyttade 9 cm bakåt, lyftbågen/draghållaren är flyttad c:a 15 cm, vilket visade sig bli något för lite. Det blev trångt för händerna när man ska lyfta. Förstärkningarnas längd är vald för att nå till och förbi bakre boggieinfästning. Plåt och profil popnitas fast, plus att skruvar från lyftbåge och lasthållare hjälper till.

En tunn gummitatta har lagts på bakersta delen av bandtunneln för att snygga till. Tvåsitsdynan går att montera precis som i originalutförandet.

Förlängningar, se bildgalleri, som uppdateras ofta.

Flippen

Bilder:
På bilderna ser du en monter-
ning av en 384 cm matta.

Montera axeln så mycket
åt vänster i bilden som
möjligt, se bild.
Då får du en perfect och
tillräckling justering.



Förlängningssatser

04-3050
Universal 12 cm



04-3080
Yamaha 20 cm



04-3040
universal 25 mm axel
20 cm förlängning



04-3060
Yamaha 12 cm



04-3300
Lynx 20 cm



04-3000



Aluminium profiler

04-3001

Chassie 400-420 mm
längd 400 mm



P/N 04-3001 . 04-3003

Med denna profil kan man förlänga chassiet med max. 400 mm. Efter gjord förlängning får man inte montera dragkroken utan förstärkningar av chassit.

04-3003

Chassie 415-430 mm
längd 400 mm



04-3002

chassie 400-410 mm
längd 200 mm

Med denna profil kan man förlänga chassiet med max. 200 mm.

Mattskoning

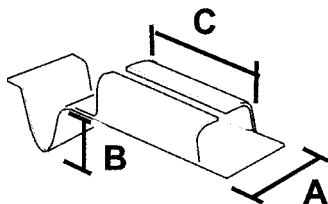

p/n	A	B	C
38-01	18	-	30
38-02	21	-	30
38-03	20	16	30
38-04	23	18	21
38-05	21	-	38
38-06	22	19	38
38-07	21	-	19
38-08	22	-	20
38-09	19	14	25
38-10	19	-	25
38-11	19	16	37



38-03

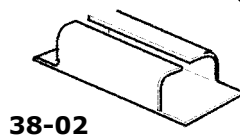
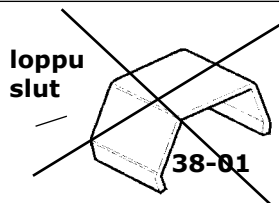

38-02

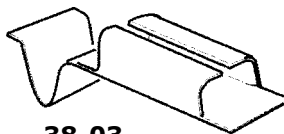

38-03

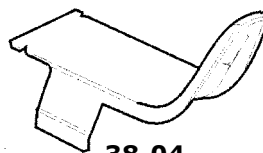

38-04

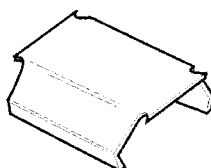

38-05

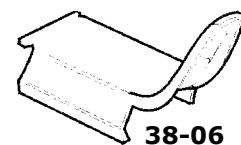

38-06

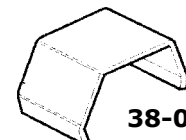

38-07

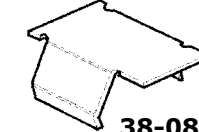

38-08



38-09



38-10

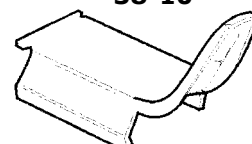

38-11

04-9925 Predator

Den gamla mattan 396 cm kan ersättas med Predator mattan 403 cm enligt bilden nedan. Efter-som ny matta är 7 cm längre så måste man montera 180 mm`s boggiehjul på bakaxeln.



345 cm till 365 cm



345 cm till 384 cm



Lynx

04-9953 38 x 325 cm



Orig. matta 320 cm
eller 330 cm lång



Extra breda belag

model skyddad/ design model

31-01 bredd 250 mm **8** mm universal model

31-02 bredd 200 mm **8** mm universal model

31-03 bredd 230 mm **8** mm universal model

31-04 bredd 195 mm **8** mm Pilot skida

31-00 Alpine II **8** mm



31-01 Vuotsolainen **31-02** Vuotsolainen



31-03 Vuotsolainen

Passar utmärkt också på andra skidor (till exempel Arctic Cat)

31-04

**Vuotsalainen för Pilot / RMK skida
design skyddad. bredd 195 mm, 8 mm**

Man kan montera 1, 2, eller 3 styrstål, men det går lika bra med ett.

Marknadens bästa skidbelag, 8 mm tjockt och gjort av HPDE material av högsta klass. Passar skidorna perfekt.

Dessa skidbelag tillverkas av Lokari yhtiöt i Rauma. Produktnummer och text Teo Lehtimäki Oy är tryckt på varje belag. Dessa tål -60 celsius.

Man kan använda dessa skidbelag utan skida om man bygger bryggan själv t.ex med aluminium, som enligt racingförarna fungerar alldeles utmärkt.



skidbelag för plastskidor



33-10 Arctic Cat



33-30 Katamaran skida



33-40 Polaris



33-60 Skidoo / Lynx flex



**33-20 CTRL skida
ej förborrat, passar på andra mod.**



33-50 Pilot, smal



33-70 Skidoo1996-



33-80 Yamaha SRX 1998-



**33-90 Yamaha 2000 / Skidoo / Lynx
passar till många andra modeller
Multipurpose modell.**



**33-99 Yamaha RX-1
text 33-99 mellan bakre hål och
text 33-90 YA, liten, liten text.**

Skidbelag 8 mm HDPE



32-61 Lynx



32-41 Polaris 1993-



32-51 Polaris -92, Ockelbo



32-81 Yamaha Viking



32-88 Yamaha Phaser 98-



32-91 Yamaha V-max 94-

31-03 L Vänster 230 mm Vuotsolainen för Pilot skida
31-03 R Höger 230 mm Vuotsolainen för Pilot skida



Begränsat antal, man kan använda 31-04

Vuotsolainen för Pilot skida

Nyhet 31-04



Den här Vuotsolainen passar på alla året 2006- skidor om skidans bredd är max. 175 mm. Bredd 195 mm.

Polaris plastskida m.fl. 2007

31-04



MM148
MM202

31-04

Yamaha, bred skida m.fl 2007

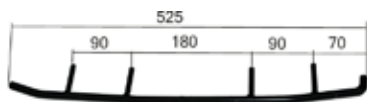

MM139



31-04

Yamaha, smal skida m.fl. 2007

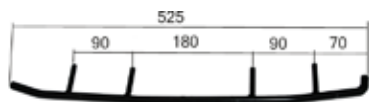

MM139



31-04

CTRL skida Lynx



MM186
MM243

Skidbelag 8 mm HDPE



32-01

Arctic Cat



32-06

Arctic Cat



32-00

Ockelbo



32-11

Trapper, Nordik



32-99

Safari, Scandic 380



32-21B

Formula, Snowexpert



Med den här skidan passar vanligt styrstål **MM277** och Coromant **MM147 33-90** passar på den här smala skidan utmärkt.

31-06 Bukplast
6 x 800 x 1000 mm

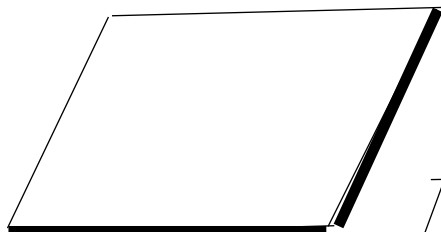

31-00 Alpine II



Plast yta

31-07

8 x 150 x 3000

31-08

8 x 150 x 2000

Glidskenor

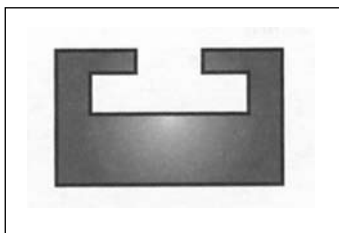

30-01 140cm svart

30-601 140 cm grafit

30-010 **163 cm** svart

Passar på: Lynx- alla modeller
Ski-Doo, Trapper, Nordik-300,500,600

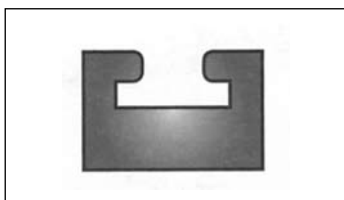

30-10 140 cm svart

30-610 140 cm grafit

30-410 163 cm orange

Passar på: Arctic Cat, alla modeller, efter -78



30-167 167 cm svart

Passar på: Arctic Cat, Super Jag

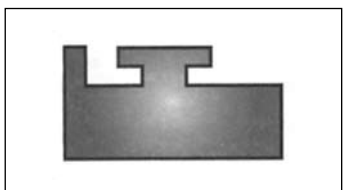

30-15 140 cm svart

30-615 140 cm grafit

30-150 **145 cm** svart, ny

Passar på: Polaris, alla modeller

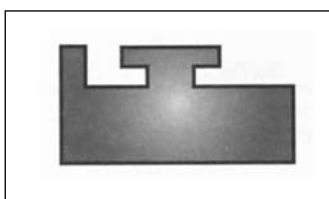

30-618 140 cm grafit

Passar på: Polaris- Storm, XCR, bred profil

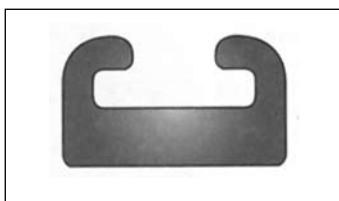

30-260 140 cm grafit

30-360 140 cm gul

Passar på: Skidoo, stor prof. 2005-

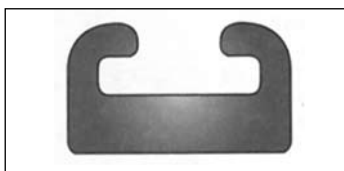

30-240 **163 cm** svart, ny

Passar på: Polaris 2003 mountain

Glidskenor

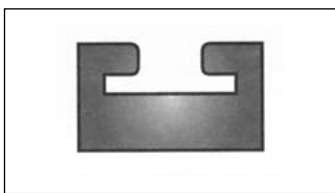

30-16 140 cm svart

30-616 140 cm grafit

Passar på: Yamaha Viking, Exciter 87-90, Phaser 90

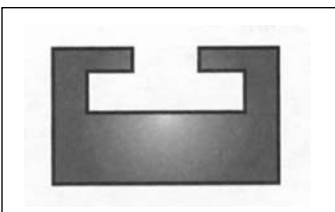

30-00 155cm vit

Obs. öppning större än 30-01 Ski-Doo

Passar på: Nordik- 377 R, 540, 550

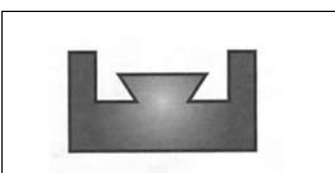

30-12 140 cm svart

30-312 140 cm pink

30-612 140 cm grafit

Passar på: Yamaha- mfl. Phaser, Ovation, SRV, SS

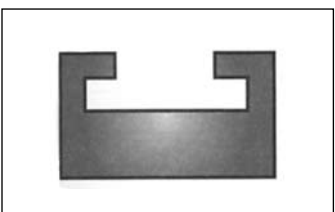

30-20 140 cm svart

30-620 140 cm grafit

30-200 **145 cm** svart, ny

Passar på: Yamaha, ny profil

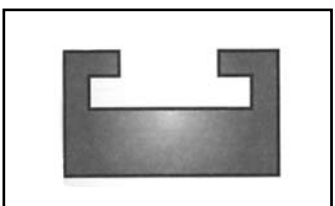

30-625 145 cm grafit

Passar på. Yamaha phaser 2007-
också några Yamaha mod. 2006-

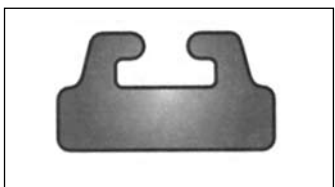

30-21 140 cm svart

30-621 140 cm grafit

30-210 **163 cm** svart, ny

30-321 **140 cm** gul

Passar på: Ski-Doo, ny profil, Lynx G-type

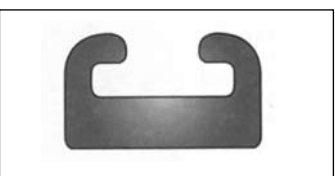

30-23 140 cm svart

30-623 140 cm grafit

30-230 **167 cm** svart, ny

Passar på: Polaris 2000 profil

Drivhjul



20-5287



20-5289



37-03



37-04



21-07N



37-06



21-08AC

Kuggghjul

20-5285

Bakre kuggghjul./ delning 2.00
9 kuggar, bredd 25 mm
Passar på: Ockelbo

20-5286

Bakre kuggghjul./ delning 2.00
9 kuggar, bredd 30 mm
Passar på: Ockelbo, Nordik, Trapper, Lynx

20-5287

Bakre kuggghjul./ delning 2.00
11 kuggar
Passar på: Nordik 300, Lynx 539 4211

20-5288

Bakre kuggghjul./ delning 2.00
10 kuggar
Passar på: Nordik 540, 550, PSS

20-5289

Bakre kuggghjul./ delning 2.52
för invändigt drift Challenger 04-9806
Passar på: Lynx, Nordik

37-00

Drivhjul, 9 kuggar/bredd 22 mm

37-01

Drivhjul, 9 kuggar/bredd 30 mm

37-02

Drivhjul. 10 kuggar/bredd 30 mm

37-03

Drivhjul 11 kuggar 430 0103

37-04

Drivhjul, 11 kuggar, 6-kant drivaxel

37-06

Boggiehjul för metalflänsar

21-08AC

Drivhjul, 8 kuggar, 24 mm 6-kant

21-08LY

Drivhjul, 8 kuggar, 31 mm 6 kant

21-09PO

Drivhjul, 9 kuggar, 24 mm 6-kant

21-09LY

Drivhjul, 9 kuggar, 31 mm 6-kant

21-07K

Drivhjul, 7 kuggar, 24 mm 6-kant

21-07G

Drivhjul, 7 kuggar, 26 mm 6-kant

21-07N

Drivaxel, 7 kuggar, 4-kantig drivaxel

Boggie hjul

20-117 4625 svart 6202-5/8
Passar på Polaris dia 117

20-108 4250 svart 6202-5/8
Passar på Ski-Doo 414 5759, Polaris dia 108

20-127 5000 svart 6202-5/8 lynx
Passar på Lynx 143 0701, Ockelbo dia 127



20-133 12993 svart 6004
Passar på Lynx 440 0410 dia 133

20-135F silver, full moon
20-135 silver 6205



Passar på Ski-Doo 572 0110, Nordik dia 135

20-5350 silver 6205 + 3/4
Passar på Polaris dia 135

20-5630 svart 6205 + 5/8
Passar på Arctic Cat dia 143

20-155 svart dia 155 6205
Passar på Ski-Doo, Nordik

20-180 silver dia 180 6205 lynx

20-190 svart dia 190 6205



20-190

20-165K gul dia 165

20-165S blå dia 165 6205

20-165P röd dia 165 6205

20-6380H silver dia 160 6205



20-130 svart dia 130 6004 yamaha

20-131 svart dia 180 6204 yamaha



Insats hylsor

20-34 hylsa 3/4 " par

20-58 hylsa 5/8 " par

Bakfjäder / kraftiga /

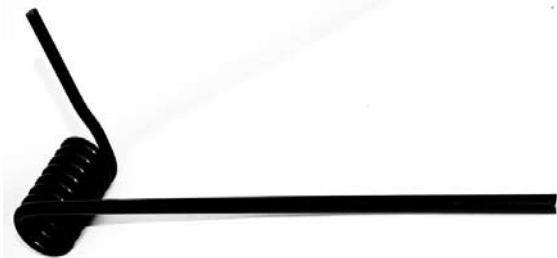

40-AC 11,5 mm
Arctic Cat senaste modeller

parvis



40-POLA 11,5 mm
8 varv lindat
Polaris, Skidoo, Lynx



40-VI 12,0 mm
Yamaha Viking



40-PO 11,5 mm
9 varv lindat
Polaris 1990 fr.o.m



40-EDGE 11,0 mm
Polaris EDGE boggie



40-POL 11,5 mm
Polaris till 1989 med krok

Bakfjäder / standard /



41-8805 Lynx Ranger m.fl

parvis



41-4175 Lynx 3900 S



40-4721 Nordik 500-600



41-1531 Lynx



41-4277 Lynx 10,0 mm
Fjädrarna på bilderna är högerlindade



41-4500 Lynx 9,0 mm



40-4716

Framfjäder / standard / parvis



41-3281 8,0mm m.fl. Lynx 250,3900

41-3000 9,0mm m.fl. Lynx 5900



41-8797 10mm m.fl. Ranger King
538797, 538798

41-8796 9,0mm 538796, 538795



41-1530 9,0mm mm Lynx 5900,
krok och ring

40-4715 8,5mm Nordik 500, 540, 550, 600



40-CA 8,0mm m.fl. Karibo, Arctic Cat

Startfjäder

01-1560 Rotax 414 783 400

01-158 Rotax 420 939 115

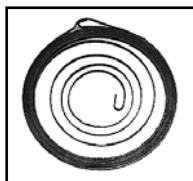

01-2080 Arctic Cat 3001-077
Polaris 308-3185
Yamaha 8YO-15713-00-00

01-2083 Arctic Cat 3002-921
Polaris 308-3495

01-206 Sachs

01-207 Kohler

Startklacksatser Rotax



01-153



01-154

Bakaxlar / boggieaxlar



11-02	3450701	Lynx 250, 360
11-03	3501775	Lynx GLX, 5900, 650
11-04	3501911	Lynx GLX, 5900, 650
11-08	5492814	bakaxel Lynx 250
11-09	5493615	bakaxel Lynx 5900
11-10	5496216	bakaxel Lynx 360, 3900
11-11	05032390	bakaxel Nordik 500, 540
11-12	05032389	bakaxel Nordik 300, 377R

Variator axlar



11-20	5394111	Lynx 250S, 3900S
11-21	5398073	Lynx 360S, Ranger
11-22	539990	Fox -99
11-23	5146138	Fox 00-
11-25	875138073	Syncro kopling

Syncro drevsats



43-65	1992 fr.o.m
nedre, bred	z=64 8751-55048
mellan, vänster	z=33 8751-47643
mellan, höger	z=33 8751-47644
43-64	till 1992
nedre, bred	z=64 8751-55048
mellan, vänster	z=31 8751-47202
mellan, höger	z=31 8751-47203

Dragkrok



12-01



12-02



12-03 Polaris

Kullager



35-6201
35-6202
35-620258

hål x ytterdiameter x bredd

12x32x10 koyo
 15x35x11 koyo
 15,875x35x11 rom.

35-6203
35-6004
35-6204N

17x40x12 koyo
 20x42x12 koyo
 20x47x12 koyo



35-6303
35-6205N
35-CB205

17x47x14 koyo
 25x52x15 koyo
 25x52x15 koyo

35-6005
35-6006
35-6008

25x47x12 koyo
 30x55x13 koyo
 40x68x15 koyo



35-6205LU

25x52x15 NTN, Polaris kedjehus

35-SA205
35-6022

25,4x52x15 excenter
 22x44x12 Yamaha drivaxel

35-6228
35-UC205
35-UC205T

28x58x16 Yamaha
 25x52x17 Lynx drivaxel
 25,4x52x17 Lynx variatoraxel



35-SB205
35-SB205T
35-3205

25x52x15
 25,4x52x15
 Lynx växellåda, 2-rad
 25x52x21



Ramlager

35-6304
35-6305
35-6305NR

20x52x15 c3 koyo
 25x62x17 c3 koyo
 25x62x17 NR koyo

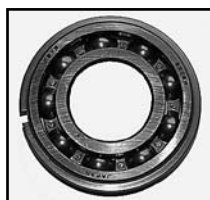

35-6206
35-6206NR
35-6306NR

30x62x16 c3 koyo
 30x62x16 NR koyo
 30x72x19 NR koyo

35-6207
35-6207NR

35x72x17 c3 koyo
 35x72x17 NR

Tändstift

BOSCH



05-B8

BR8ES resistorstift

05-B9

BR9ES resistorstift

ALT-primär variator**Arctic Cat**

st

gr

**Clutch ALT model**

		prod.	fjäder	brickor	vikt
alla modeller	1970-80	1213	fråga		
Jag 4000	1981	1213	3	10	
Pantera 5000	1977-81	1213	3	12	
Panther 4000	1977-81	1213	3	9	
El Tigre 5000	1978-80	1213	3	12	
Trail Cat 4000	1980-81	1213	3	10	

**15-1213A****15-0513A****15-2913A****15-3113A****15-1713A****Skidoo**

Alpine640	1969-75	0913	3		
Alpine640	1975-82	0613	3		
Citation 4500/SS	1980-83	0513	1	9	
Citation LS/E	1985-91	3913	1	12	
Elan 250/247cc	1971-96	1013	1	12	
Elan 248-294 cc	1973-79	1013	1	4	
Elite 464 cc	1981-82	0513	1	12	
Everest TNT	1975-79	0513	1	5	
Everest 444/464	1978-83	0513	1	12	
Everest 500	1980-83	0513	1	9	
Olympic mod	1969-75	1013	fråga		
Skandic 277	1983	3913	2	6	
Scandic 377 / R	1982-87	0513	1	9	
Tundra LT / LTS	1985-92	3913	1	12	
Skidoo modeller	1965-80	fråga			

Polaris

Polaris modeller	1970-80	2815	fråga		
Star, L/T	1983-87	2815	1	4	

Yamaha

BR 250	1982-84	2913	1	13	
BR 250 TS, T, LT	1984-01	3113	1	13	
ET 250	1977-81	1713	1	4	
ET 300	1979-84	2913	1	4	
ET 340E, T, TR	1978-88	2913	1	6	
ET 400T, TR	1989-91	2913	1	11	
EC 340 338 cc	1981-88	2913	1	6	
EC 540 535 cc	1979-82	2913	1	12	
EX 340 338 cc	1976-78	2913	1	6	
EX 440 433 cc	1976-81	2913	1	13	
Phazer 433 cc	1984-89	3113	1	13	
SRV 540	1984-91	3113	1	12	
SRX 440	1976-80	3113	1	13	
SS 440	1980-85	3113	4	13	
STX 340	1976-77	2913	1	6	
STX 440	1976-77	2913	1	13	
XLV 540	1985-90	3113	1	12	

Motoski

Motoski	1973-80	fråga	fråga	fråga	
Futura 400, E	1977-79	0513	3	8	
Futura 444, LC	1978-79	0513	3	7	
Futura 464, RV	1980-83	0513	3	10	
Futura 500	1980-83	0513	3	10	
Spirit 250	1976-83	1013	2		
Grand Prix spec	1979-81	0513	2	10	
Mirage 1.	1980-83	3913	2	10	
Sonic mod.	1979-83	0513	5	6	

Sno - Jet

Sno - Jet	1972-77	1713	2	fråga	
-----------	---------	------	---	-------	--

Lynx

			st	gr
		prod. fjäder	brickor	vikt
L 320 295 cc	197?-80	1213A	1	9
L 520 295 cc	197?-83	1213A	1	60
L 330 340 cc	197?-80	1213A	1	8
L 535 440 cc	197?-79	1213A	1	60
L 635 440 cc	197?-79	1213A	1	90
GLX 503 cc	1981-82	1213A	1	60
GLX / 5900	1984-93	0513A	1	60
L 535 503 cc	1981-83	1213A	1	60
L 535 503 cc	1984-87	0513A	1	60
L 635 / XL	1981-83	1213A	1	90
GL 3300 377 cc	1982	0513A	2	12
GL 3900 377 cc	1982-91	0513A	2	12
L 650 503 cc	1982-92	0513A	1	90
L 250, S 253 cc	1985-91	0513A	2	6
GL 3300 S 503 c	1984-89	0513A	1	7
GL 3300 377 cc	1989-90	0513A	1	12

Ockelbo

Oc 300	1978-80	3113A	2	14
Oc 600-1	1978-80	3113A	2	14
Oc 600-2	1979-81	0513A	2	60
Oc 8000	1980-88	0513A	2	80
Oc 6000	1981-88	0513A	2	60
Oc Poro	1983-85	0513A	2	6
Oc 4000	1982-83	0513A	2	7
Oc 5000	1983-88	0513A	2	70
Oc 3500	1986-88	0513A	2	6
Oc 4500	1986-88	0513A	2	60
Fighter	1988	0513A	2	10

Trapper, Nordik

Trapper 5000	1984-	0513A	1	10
Trapper 6000	1984-	0513A	1	90
Nordik 300, R	1988-	3913A	1	10

Aktiv

Aktiv modeller	1976-82	1213A	fråga
Aktiv modeller	1983-	0513A	fråga

Terri 30

Terri	1975-	0513A	5	200
-------	-------	-------	---	-----

Fjäder

1= 19-01
2= 19-02
3= 19-03
4= 19-04
5= 19-05

Primär variator

0513A= 15-0513A
0613A= 15-0613A
0913A= 15-0913A
1013A= 15-1013A
1713A= 15-1713A
2913A= 15-2913A
3113A= 15-3113A
3913A=15-3913A
5013A=15-5013A ny



fjäder 1-5



15-3913A



16-11



16-06



16-09



16-08



16-07



16-02



16-16



17-200

S4B-model

Ski-Doo



SS 25
Safari 377
Safari L, LE
Scout, Saga
Tundra 2, LT

1984
1984-88
1990-92
1989-92
1993- 97

prod.	fjäder	brickor	vikt
0513B	117	12	
0513B	102	8	
0513B	102	8	
0513B	102	8	
9713B	086	2	

st gr

15-0513B
15-3113B
15-6513B
15-9513B
15-9713B

Polaris

Lite GT,Deluxe
Sport GT
Starlite, GT
Sport touring

1991-98
1991-92
1991-93
1993-96

6513B	102	12	
6513B	102	12	
6513B	114	14	
6513B	114	12	



Yamaha

SR540
Viking 540
Exciter 570
Viking 2 540 cc

1981-87
1988-92
1987-90
1992-93

3113B	121	14	
3113B	102		90
3113B	121	14	
3113B	102		90

18-130



Lynx

GLS 3300
GLS 3500
GLS 3600
GLS 3800
L 5900 503 cc
L Forest Fox elstart

1987-89
1990-91
1990-91
1990-91
1983-93
1993-99

0513B	114	12	
0513B	117	11	
0513B	121	13	
0513B	121	13	
0513B	102		60
9513B	102	7	

18-030



18-100



17-050



17-051



18-060
18-090



18-120



17-090



16-07



16-08

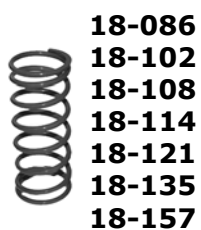

18-200
18-201

fjäder 086 mm
fjäder 102 mm
fjäder 108 mm
fjäder 114 mm
fjäder 121 mm
fjäder 135 mm
fjäder 157 mm
avdragare M14x1,5 L-30
avdragare M14x1,5 L-120



18-170
18-171

18-140
17-112
18-160

skruv
Polaris skruv

låsbricka
mutter
bricka

Arctic Cat**max 580 cc****CV-tech, primär****prod. fjäderbrickor**

Jag modeller 440 fc	1985-99	0148C	108	8
Jag modeller 340 fc	1987-99	0148C	108	6
Jag liq, 440 lc	1996	0148C	157	9
Manx modeller 340 fc	1991-93	0148C	108	6
Pantera 440 lc	1985-92	0148C	157	9
Pantera 550 lc	1993-95	0148C	157	14
Pantera 580 lc	1997-99	0148C	157	14
Panther 500 fc	1986-88	0148C	108	9
Panther 440 fc	1989-90	0148C	108	8
Panther 340 fc	1998-00	0148C	108	6
Bearcat 340	1995-	0148C	108	6
Bearcat 440	1995-	0148C	108	8
Bearcat 550 lc	1996-	0148C	121	15
Cheetah 500 fc	1986-90	0148C	108	9
Cheetah 440 lc	1991-94	0148C	157	10
Cougar 500 fc	1985-90	0148C	108	9
Cougar 440 lc	1991-94	0148C	157	9
Cougar 550 lc	1995-98	0148C	157	14
EXT modeller 550 lc	1991-93	0148C	157	14
EXT modeller 580 lc	1993-97	0148C	157	12
El Tigre 5000 lc	1987-88	0148C	157	9
El Tigre 6000 lc	1978-79	0148C	157	9
El Tigre 6000 lc	1980-85	0148C	157	12
El Tigre 6000 lc	1986-89	0148C	157	13
El Tigre EXT 530	1989-91	0148C	157	13
Panther 440 fc	1984-85	0148C	157	8
Panther 440 lc	1996	0148C	157	9
Panther deluxe MC	1991-01	0148C	108	8
Panther 550 lc	1997-01	0148C	157	14
Prowler 550 lc	1995	0148C	157	14
Prowler 440 lc	1991-94	0148C	157	9
Puma modeller 340	1994-97	0148C	108	6
Z, ZL, ZR 440 lc	1993-01	0148C	157	9
ZR 580, EFI lc	1993-97	0148C	157	13

**15-0148C****19-130****Yamaha****max 570 cc****CV-tech, primär**

Exciter II EX 570	1991-93	0151C	157	14
Phaser modeller 485 cc	1992-99	0151C	108	10
Viking III 540E 535 cc	1993-01	0151C	157	13
VX 500 XT 494 cc	1996	0151C	157	13
VX 500, E, DX, ST	1994-96	0151C	157	13
Venture modeller 485 cc	1991-01	0151C	157	10
Venture 500 494 cc	1997-01	0151C	157	12
V-max 500 modeller, 494 cc	1997-99	0151C	157	12

**15-0151C****19-030****19-100****17-040 Kåpa**

CV-tech, primär Skidoo

max 583 cc



15-0147C



15-0148C



19-130

			prod.	fjäder	brick.
Escapade 503 cc	1987-89	0148C	108	9	
Formula 500 494 cc	1997-99	0148C	157	12	
Formula GT 582 cc	1993-97	0148C	157	13	
Formula MXZ 467 cc	1993-94	0148C	145	12	
Formula MXZ 454 cc	1995	0148C	145	12	
Formula MXZ 440 cc	1997-99	0147C	108	7	
Formula MX,LT, 467 cc	1985-93	0148C	145	12	
Formula Mach 1 583 cc	1989-90	0148C	157	13	
Formula Plus 583 cc	1992	0148C	157	13	
Formula Plus 537 cc	1985-91	0148C	157	13	
Formula Plus 582 cc	1992-93	0148C	157	13	
Formula S377 377 cc	1996-99	0147C	108	6	
Formula SL 503 cc	1995-99	0147C	108	9	
Formula SLS 494 cc	1996	0148C	157	12	
Formula SP,SS 462 cc	1985-86	0148C	145	12	
Formula ST, GT470	1994-95	0148C	145	12	
Formula Z,STX,LT 583	1994-99	0148C	157	14	
Grand Touring 500 cc	1996-99	0147C	157	11	
Grand Touring 583 cc	1995-99	0147C	157	13	
Safari 503, R 503 cc	1988-93	0148C	108	9	
Safari Cheyenne 503 cc	1989-91	0148C	108	9	
Safari Deluxe, L 377 cc	1993-94	0148C	108	6	
Safari GL 447E 477 cc	1984	0148C	108	7	
Safari GL LC 467 cc	1990-92	0148C	145	12	
Safari LC, LCE 467 cc	1990-92	0148C	145	12	
Safari LX, LXE 447 cc	1990-91	0148C	108	7	
Safari Rally E 503 cc	1994	0147C	108	9	
Safari Voyager 503 cc	1989	0148C	108	9	
Scandic 503	1987	0148C	108	9	
Scandik II 377R, 377cc	1992-01	0147C	108	6	
Scandik II 503R, 503 cc	1993-01	0147C	108	9	
Wide Track 503 cc	1996-	0147C	108	9	
Wide Track 494 cc	1997-99	0148C	135	12	
Stratos, E 503 cc	1987-88	0148C	108	9	
Summit 470 467 cc	1994	0148C	145	12	
Summit 500 497 cc	1996-99	0148C	157	13	
Summit 583 583 cc	1995-97	0147C	157	14	

CV-tech, primär Polaris

max 580 cc



15-0149C



Cutlass 440	1981-52	0149C	108	12
Indy 400 classic	1984-91	0149C	157	11
Indy 440, sks, xcr	1992-98	0149C	108	12
Indy 500 carb.sks,rmk	1995-98	0149C	157	12
Indy 500,sks,sp,efi	1989-98	0149C	157	12
Indy 500, classic	1989-01	0149C	157	12
Indy classic,touring	1994-01	0149C	157	12
Indy sport,touring	1993-01	0149C	157	11
Indy sport, GT	1987-90	0149C	108	12
Indy super sport	1995-99	0149C	145	12
Indy mallit 550 cc	1998-	0149C	157	12
Indy trail 440 cc	1983-85	0149C	157	12
Indy trail deluxe	1993	0149C	157	12
Indy trail mallit 500cc	1988-01	0149C	145	12

Fjäder

Obs: avdragare samma som TRA

Polaris**max 580 cc****CV-tech, primär****prod. fjäder vikt**

Widetrak	1990-93	0149C	145	12
Widetrak GT	1995-98	0149C	145	12
Widetrak LX	1994-	0149C	145	12
Indy XCF 440 cc	1997-99	0149C	108	12
Indy XLT,sks,sp 580	1993-94	0149C	157	13
Indy Transport	1996	0149C	108	12
Long track, RLR	1983-89	0149C	108	12
SS,Sport,Sprint,ES	1983-87	0149C	108	12
Star trak	1988-90	0149C	135	14
TC-C 440 cc	1981-82	0149C	145	11
TX-L 340 cc	1981-82	0149C	145	9

**Lynx****max 583 cc****CV-tech, primär****prod. fjäder vikt**

Enduro 600 583 cc	1993-	0148C	157	12
Enduro 500 F 503 cc	2000-	0148C	135	13
Enduro 550 F 550cc	2003-	0148C	157	12
Explorer 500 503 cc	2001-	0148C	108	11
Explorer 550F 550 cc	2003-	0148C	135	12
Cobra 536 cc	1993-	0148C	157	13
Cobra Touring 536 cc	1993-	0148C	157	12
GLS 3500 fc 503 cc	1993-	0148C	135	12
GL 360S 377 cc	1994-	0148C	108	9
Ranger King, LTS 377 cc	1994-	0148C	108	9
Ranger King 503 cc	1996-	0148C	108	12
Ranger 2000, FCE 503 cc	2000-	0148C	108	12
Ranger LCE 496 cc	2002-	0148C	108	11
Ranger 550F 550 cc	2003-	0148C	135	12
Light 377 cc	1994-	0148C	108	10
Light Touring 377 cc	1997-	0148C	108	10
GLX 5900 503 cc	1994-	0148C	108	10
GLX 5900 LC 496 cc	1999-	0148C	108	11
ST 500/5900 496 cc	2000-	0148C	108	11
650 Syncro 503 cc	1994-	0148C	108	14
Forest Fox 377 cc	1996-	0148C	108	9
Forest Fox 443 cc	1998-	0148C	108	9
Sport XR 377 cc	1997-	0148C	108	8
6900 WT 503 cc	1997-	0148C	108	14
G-Touring 583 cc	1997-	0148C	157	13
XR 400 F 377 cc	2000-	0148C	108	9
XR 500 F 503 cc	2001-	0148C	135	12
Touring 400 F 377 cc	2000-	0148C	108	10
Touring 500F 503 cc	2000-	0148C	108	11
Safari 400 377 cc	2001-	0148C	108	10

**15-0148C****19-050****16-08****16-07****19-030****19-100****19-120****19-170****19-171****19-140****17-112****18-160**

**skruv
polaris
låsbrick
mutter
bricka**

Sekundärvariator

14-00 KW-8-25-270 MVLТ

-dia 25 mm axel

-dia 270 mm

m.fl. Ockelbo. Lynx, Trapper Max 1049 rem

14-01 KW-22,2-250 NK

-dia 22,2 mm axel med 5 mm kilspår

-dia 250 mm

m.fl Terri 30

14-03 5100-0172

-dia 22,2 mm axel

-6mm kilspår

-dia 250 mm

Lynx " plåt sekundär "



Instruktioner

När du har monterat i en ny variator eller reparerat den gamla, kolla alltid fjädern i sekundärvariatorn. Väldigt ofta är den för svag och fungerar inte som den ska. Den växlar för tidigt och motorn orkar inte. Därför lönar det sig att spänna den gamla fjädern eller montera dit en ny. Du bör också alltid rengöra delarna.

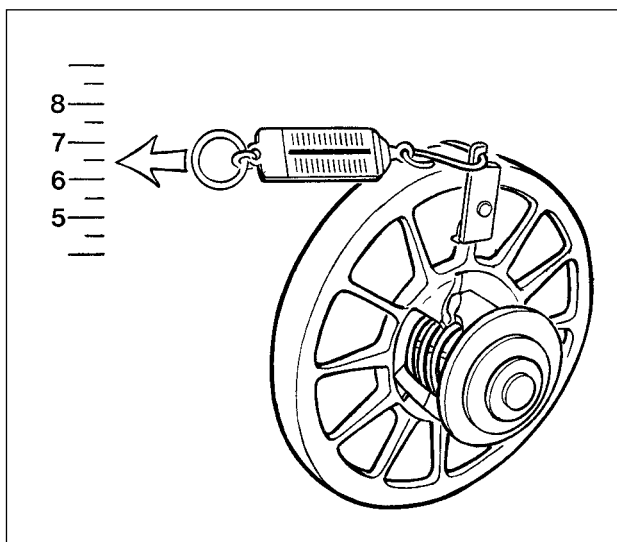

Linjering

Kolla med ett 12 mm tjockt järn eller en rak stång för linjering av variatorerna. Om det inte finns någon vridstopp eller begränsare i din skoter, som kan hindra motorn att vrida sig under drift, så måste måttet **Y** vara ca. 1,0-1,5 mm större än måttet **X**. Notera också att ny CV Tech, IBC är mindre i diameter och därför är manualens **Z** mått ej rätt.

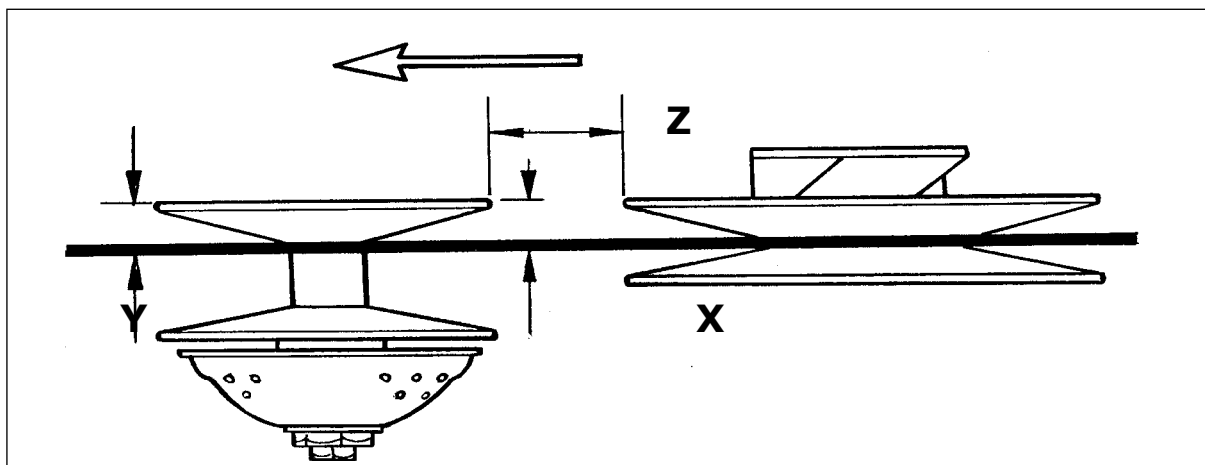

Arctic Cat Kolv	dia	cc	packning	nållager	packbox magneto	packbox variator
EXT 600 Triple 97-98; EXT 600 Tr. Touring 1998; Powder EXT 600 1997-98; ZRT 600 1995-98 09-601	66,50	594		35-503	09-14618	09-14619
Pantera 800 1998-01; ZRT 800 1995-01 09-602	72,00	794		35-523	09-14618	09-14619
ZL 500 EFI 1998-01; ZR 500, ERSI 1998-01; Powder SP 500 EFI 1999-01 09-679	71,00	497		35-523	09-14618	09-14619
EXT 580 MC; EXT 580 EFI MC 1993-97; 580 Powder SP 1995-97; ZR 580 1993-97; Pantera 580 1995-97 09-681	75,40	580		35-523	09-14618	09-14619
Wildcat 700 MC. EFI 1991-96, ZR 700 1995 09-682	81,00	699		35-523	09-14618	09-14619
EXT special 1991-92; EXT Mountain Cat 1991-92; EXT 550 EFI, EFI Mtn Cat 1993-94 Bear Cat 550WT 09-683	73,40	550	840-8182-9	35-523	09-14618	09-14619
Panther, Puma, Cheetah, Pantera 1971-1974 09-685	60,00	339				
Bearcat 550 1995-98; Cheetah 550 1994; Cougar 550 1995-98; EXT 550, EFI 1993-98; Pantera 550 1993-94; Panther 550 1997-98; Prowler 550 1995 09-687	73,40	550		35-523	09-14618	09-14619
El Tigre 440 Z 1975-77; Kawasaki Intriguer, Intruder, Invader; Drifter 440 1978-81 09-689	68,00	440	840-8059-9	35-522	09-14603	09-14603
Cheetah FC, Cougar 1986-90 09-691	70,00	500	840-8061-9	35-503	09-14603	09-14603
Bearcat 340 1995-01; Cheetah 340 1994; Jag 340 1976-77, 1987-90; Jag 3000 FA, FC 1978-80 Jag Deluxe 1987-90; Jag Mountain Cat 1990-91; Jag 340 DeLuxe 1998-99; Panther 340 1998-01 Trail Cat 3000 FC 1980; Manx, Manx Deluxe 1991-93; Manx Mountain Cat 1992-93; Puma DeLuxe 1994-97 09-692	60,00	339	840-80588-11	35-502	09-14603	09-14603
Cheetah 5000 1976-78; El Tigre 500 1976; El Tigre 5000 1977-81; Pantera 5000 1976-81; Panther 500 1976 Cougar Spec. Edition 1985; Panther 1986-88; Pantera el. 1980; Manx 2000S 1977-80 09-693	70,00	500	840-8061-9	35-503	09-14603	09-14603
El Tigre 6000 LC 1980-85 09-694	70,00	500	840-80632-14	35-503	09-14603	09-14605
El Tigre 6000 LC 1978-79; El Tigre Cross Country 1979; Pantera LC 1985-92; El Tigre 5000 LC 1987 Jag 440 LC 1987; Panther 440 LC 1996; ZL 440 1997-99; Prowler 1990-94; Cheetah Touring 1991-93; Cougar 1991-94. 09-695	68,00	440	840-8181-13	35-503	09-14603	09-14603
Bearcat 440 1995-01; Cheetah 440 1994; Panther 4000 FC 1980-81; Trail Cat 4000 FC 1980-81; Jag 4000 FC 1980-81; Jag AFS LT 1991-93; Jag FC 1985-87; Jag 440 DeLuxe 1988-99 Jag 440 Z 1991-96; Panther DeLuxe 440 1984-01; Z 440 ES 1990-01; Super Jag 1991-92 09-696	65,00	431	840-80607-10	35-502	09-14603	09-14603
Cheetah LC 1986-89; El Tigre 6000 1986-89; El Tigre EXT 1989-91; El Tigre Ext Mountain Cat 1990 09-699	72,00	529	840-80632-14	35-503	09-14603	09-14603

**Ski-Doo/
Kolv**

dia

cc

packning

nållager packbox
magnetopackbox
variator

Spirit 250 1976-78; Elan 250 E 1971-78

09-740	69,00	247	840-8119-9	35-505	09-118	09-118
09-740-02	69,50					
09-740-04	70,00					

Spirit 250 1979-83; Elan 250 1979-96

09-740-02	69,50	250	840-8024-9	35-505	09-118	09-118
09-740-04	70,00					

Rotax 253, 277, 503,521,536 Lynx, Nordik, Ockelbo, Skidoo, Trapper, Winha

09-741	72,00	253	841-8123-8	35-505	09-126	09-146
09-741-01	72,25	277	841-8300-9	35-505	09-168	09-169
09-741-02	72,50	503	840-8162-8	35-505	09-165	09-167
09-741-04	73,00	521		35-505	09-167	09-165
09-741-06	73,50	536	840-8170-20	35-505	09-167	09-165

Olympic 320, 320E 1969; Olympic 300, S, M, 1971-77

09-742	76,00	319		35-505	09-118	09-118
09-742-02	76,50					

Elan 250 1973-79

09-745	54,00	247		09-514	09-118	09-118
---------------	-------	------------	--	--------	--------	--------

Olympic 335 1969-72; Skandic 1970-73

09-746	78,00	335		35-505	09-118	09-118
---------------	-------	------------	--	--------	--------	--------

TNT 340, 1972-76; lymptic 340,E 1975-79;Everest 340, E 1977-79; Futura 340 1975; Nuvik 340,E 76-79

09-747	59,5 left	339		35-505		
09-748	59,5 right	339		35-505	09-167	09-167

Blizzard 6500 Plus, 7500 Plus, Cross Country 1978-81; Super Sonic 1979-81

09-750	59,50	339		35-505	09-165	09-167
09-750-02	60,00					

Rotax 377 ; Lynx, Nordik, Ockelbo, Skidoo, Trapper, Winha

09-751	62,00	377	840-80238-7	35-505	09-165	09-167
09-751-01	62,25					
09-751-02	62,50					
09-751-04	63,00					

Rotax 447; Lynx, Ockelbo, Skidoo, Trapper

09-752	67,50	447	840-8124-11	35-505	09-165	09-167
09-752-01	67,75					
09-752-02	68,00					
09-752-04	68,25					

Everest 440 FC 1974-79; TNT 440 FC 1975-78; Olympic 1977; Futura 440 1975-79; Nuvik 440 1977

09-758	67,5 left	436,6		35-505	09-122	09-116
09-758-02	68,00					
09-759	67,5 right	436,6		35-505	09-167	09-167
09-759-02	68,00					

Ski-Doo Kolv	dia	cc	packning	nållager magneto	packbox variator
-----------------	-----	----	----------	---------------------	---------------------

Blizzard 9500 1979-82; Ultra Sonic 1980-82

09-760	67,50	436,6		35-505	09-167	09-167
09-760-01	67,75					
09-760-02	68,00					

Rotax 444, 467; Elite 450 LC 1978-79; Everest 444 LC 1978-79; Everest 464 LC 1980-83; SS-25 1984
Grand Tour. 470 1995; Formula SS 1985; Formula St 1994; Formula SP 1985-86; Formula MX, LT, XTC 1985-
95 Formula MXZ 1993-94; Safari GLX, LC, LCE 1990-92; Summit 470 1994-95

09-761	69,50	436,6		35-505	09-167	09-167
09-761-01	69,75					
09-761-02	70,00	462,8		35-505	09-167	09-165
09-761-04	70,50					

Alpine 640 1969-82; Nordic 640 1970-74; TNT 640 1971-72; Valmont 1971-72

09-762	76,00 left	635		35-505	09-103	09-103
09-762-02	76,50					
09-763	76,00 right	635		35-505		
09-763-02	76,50					
09-763-04	77,00					

Rotax 583, 621; F Mach 1, XTC 1989-92; F Plus, E, XTC,X 1992-93; F Plus EFI 1993-94; F GT 580 1993-96;
F STX 1994-96; Summit 1994-96; F Z 1994-96

09-772	76,00	583		35-505	09-167	09-165
09-772-01	76,25					
09-772-02	76,50	617			center	09-16002
09-772-04	77,00					

Rotax 670; Mach 1 X 1993; Mach 1 1993-96; MXZ 670 1996-99; GT SE 1994-96; F SS 670 1995-96; Summit
670

09-773	78,00	669		35-524	09-167	09-165
09-773-01	78,25					
09-773-02	78,50					
09-773-04	79,00					

Formula 3 600 1995-97

09-774	64,50	600		35-503	center 09-11301	09-165 09-170
---------------	-------	------------	--	--------	--------------------	------------------

Rotax 500, 780; F Z 500 1999; F 500, DLX, SLS 1996-00; GT 500 1996-99; Mach Z 780 1993-97; MXZ 500 98-
Scandic WT LC 1999-00; Summit 500 1996-99; Touring 500 LC 2000

09-780	69,50	500		35-505	09-165	09-165
09-780-02	70,00	779	center	09-165 or 09-16003	09-11301	09-170

Rotax 700; F 3 700 1998-00; GT 700 1998-00; GT SE 1997-98; Mach 1 700 1997-00

09-781	69,80	699		35-503	09-11301	09-170
---------------	-------	------------	--	--------	----------	--------

Mach Z 800 1997-99; F 3 800 1999

09-782	70,50	796		35-503	center 09-170	09-16003 09-170
---------------	-------	------------	--	--------	------------------	--------------------

Formula 700, Legend 700, MXZ 700 Summit 700 2000-2002

09-783	78,00	700				
---------------	-------	------------	--	--	--	--

Formula 600 1999-01, Formula 600 GS 2001, Formula Z 1999-00, GT 600 1999-01, MXZ 600 1999-02
Scandic 600 WT L/C 2001-02, Summit 600 1999-01, GT 600 GS, SE, Sport, Legend 600 2002
MXZ 600 Adr., Renegade, Sport, Trail, RER Sport, Sport 2002, Lynx 600 L/C mallit

09-785	76,00	597				
09-785-02	76,50					

Polaris Kolv	dia	cc	packning	nållager	packbox magneto	packbox variator
-----------------	-----	----	----------	----------	--------------------	---------------------

Charger, Mustang 488 1971; Voyager 488 1971; Colt 250 1972-78; Custom 2 1971; TC 250 1974-75; Electra 250 1975-77; Gemini 244 1979-83; Star 1983-90; Startrak 1987-90; Starlite Gt 1991-95

09-700	72,00	488				
09-700-02	72,50	244	840-8069-935-520		09-14102	09-14102
09-700-04	73,00					

Colt 250 1976-78

09-702	53,50	250		35-520	09-14103	09-14102
---------------	-------	------------	--	--------	----------	----------

Starfire 250 1976; TX 250 1976-79

09-703	53,40	250		35-520	09-14103	09-14102
---------------	-------	------------	--	--------	----------	----------

TX 440 1973; Electra 440 1974-77; Cobra 440 1978-79; Galaxy 440 1980-81; Cutlass 440, E 1981-82; TX-C 440C 1981; Long Track 1983-86; Sport, Super Sport SS 1983

09-704	67,72	432	840-8110-10	35-520	09-140	09-140
09-704-02	68,22				09-14202	09-14202

TX 440 1976-80

09-705	67,75	440		35-520	09-140	09-140
---------------	-------	------------	--	--------	--------	--------

Indy 400 1984-1991; Indy 600 1984-87

09-707	65,00	398, 597		35-503	09-14202	09-14202
09-707-01	65,25					
09-707-02	65,50					
08-707-04	66,00					

Colt SS 340 1977; Cobra 340 1978-79; SS 340 1979; Apollo, Galaxy, Cutlass 340 1979-1981

09-708	61,78	333	840-8109	35-520	09-14102	09-14102
09-708-02	62,28					

Sprint ES 1986-90; Indy Sport, GT 1987-90; Indy Lite, GT, Starlite 1991-93

09-709	62,25	339	840-81087-7	35-503	09-14202	09-14202
09-709-01	62,50					
09-709-02	62,75					

TXC 440 FC 1982; Indy Trail 1983-1986; Long Track 1984-90; Indy Sport 1991-98; Sport GT 1991-93; Sport Touring 1995-98; Super Sport 1995-96; Transport 1996-98

09-710	67,75	440		35-503	09-14202	09-14202
09-710-02	68,25					
09-710-04	68,75					

Indy 500 LC, Classic 1989-00; Indy 500, SKS, SP, 1990-98; Indy 500 EFI 1992-98; Indy Classic Touring 1993-94; Indy Widetrack 1997-98

09-711	72,00	488	840-8188-14	35-503	09-14202	09-14202
09-711-01	72,25		841-8188-18			
09-711-02	72,50					
09-711-04	73,00					
09-711-06	73,50					

Polaris Kolv	dia	cc	packning	nållager	packbox magneto	packbox variator
Indy Trail FC 1986; Indy Tr. DeLuxe 1988-92; Super Sport 1997-98; Supertrac 1991-93; Indy Trail, Touring 1994-99						
09-712	72,00	488	840-81108-9	35-503	09-14202	09-14202
09-712-01	72,25					
09-712-02	72,50					
09-712-04	73,00	Änvänd 09-711 kolv				
Indy 650, SKS 1988-93; Indy 650, RXL, SKS, 1990-97						
09-713	67,75	648	840-8187-15	35-503	09-14202	09-14104
09-713-01	68,00					
09-713-02	68,25					
09-713-04	68,75					
Indy 580 XLT, SKS, XLT SP 1993-94						
09-714	64,00	579		09-525	09-14202	09-14202
09-714-01	64,25					
09-714-02	64,50					
Indy 440 XC 1992; Indy 440 XCR 1993-94; Indy Trail DeLuxe 1993						
09-715	67,72	440		35-525	09-14202	09-14202
09-715-01	67,97					
09-715-02	68,22					
Indy XLT 600 1995-98; XLT SP 1997-98; Indy XCR 600 1995-97; XC 600 1997						
09-716	65,00	597		09-525	09-14202	09-14202
09-716-01	65,25					
09-716-02	65,50					
Indy Lite, DeLuxe; Indy Lite Gt 1994-98; Indy Lite Touring 1998						
09-717	62,30	340	840-81087-7	35-525	09-14202	09-14202
09-717-01	62,55					
09-717-02	62,80					
09-717-04	63,30					
Indy Ultra SP, Ultra SPX, SE, Ultra Touring 1996-97						
09-718	66,50	679		35-503		
Indy Storm 800 1994-98						
09-719	72,00	794				
RMK 500, SKS 2000-02, 500 XC1999-02, Indy500 99						
09-720-02	71,00	500				
Indy 600 Classic, Touring 2001, Indy 600 Touring 2000, 600 XC SP, Edge 2000, 600 XC SP 2001						
09-728	77,25	600				
Kolv Kohler						
Kohler 340 motor						
09-670	62,00	340	840-8092-10	35-520	09-104	09-113
09-670-01						
09-670-02						
09-670-04						
Kolv Sachs						
Sachs 440 motor						
09-SM127	67,40	436			09-116	09-127

Yamaha	dia	cc	packning	nållager	packbox magneto	packbox variator
Br 250 1982-94; Br 250T, TS, 1985-00; BR 250 TS 1984-97						
09-800	70,00	246		35-525	09-131	09-14305
09-800-01	70,25					
09-800-02	70,50					
ET 250,1977-1981						
09-801	72,96	246			09-505	
09-801-01	73,21					
09-801-02	73,46					
09-801-04	73,96					
EC 340 1982-88; ET 340 1978-88; CS 340 E 1989-00						
09-802	60,00	337	840-8145-11	35-522	09-131	09-132
09-802-01	60,25					
09-802-02	60,50					
09-802-04	61,00					
GP; TL, 433 1975; EX 440 1976-81; GP 440 1976-78; PR 440 1976-77; STX 1976-77						
09-806	68,00	433	840-8028-8	35-505	09-143	09-135
09-806-01	68,25					
09-806-04	69,00					
09-806-06	69,50					
SS 440 1980-83						
09-807	66,00	440		35-505	09-143	09-137
09-807-02	66,50					
EC 440 1979-84; SR 540 1980-91; XL 540 1985-90; VK 540 1988-00						
09-808	73,00	535	840-81401-14	35-521	09-143	09-137
09-808-01	73,25					
09-808-02	73,50					
09-808-04	74,00					
PZ 480E, PZ 480 1984-98; PZ 480 ST 1991-98; VT 480 1991-97; VT 480 GT 1993-97; VT 480 TF/XL 1993-00 Phaser 500 1999-00; Phaser 500 ML 2000; Phaser Mountain 480 1999; Venture 500 1999-00						
09-813	72,00	485	840-81363-11	35-505	09-14303	09-14302
09-813-01	72,25					
09-813-02	72,50					
09-813-04	73,00					
VMX 540 1983-91						
09-816	73,00	535		35-521	09-14306	09-14301
Exciter 570 1987-90; Exciter 2 1991-92						
09-817	73,00	569	840-81261-11	35-521	09-14313	09-14301
09-817-02	73,50					
09-817-04	74,00					
V-Max 500 LE, DX, ST, 1994-96						
09-825	68,00	493		35-521		
V-Max 600, LE, DX, ST, 1994-96						
09-826	74,80	598		35-521		
09-826-02	75,30					

Kolvringar

Rotax 503-253

10-741-00
10-741-01
10-741-02
10-741-04

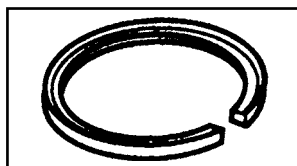

Rotax 377

10-751-00
10-751-01
10-751-02
10-751-04

Kolvbultar

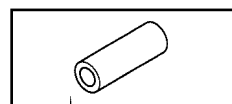

11-741
11-751

Nållager

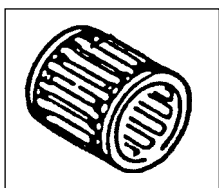

35-500 19 x 23 x 24 (1414)
35-501 16 x 20 x 22 (1404)
35-502 16 x 21 x 20 (1407)
35-503 18 x 23 x 22 (1413)
35-505 18 x 22 x 22 (1410)
35-506 16 x 20 x 24 (1406)
35-508 20 x 24 x 19 (1415)

35-510 18 x 22 x 28 (1411)
35-512 20 x 24 x 24 (1412)

35-513 16 x 20 x 20
35-514 15 x 19 x 20
35-515 16 x 22 x 17
35-517 20 x 24 x 30
35-520 18 x 23 x 21
35-521 20 x 25 x 24
35-522 16 x 20 x 22,5
35-523 20 x 26 x 24

Packboxar

Arctic Cat

09-14600 30x62x10
09-14603 30x65x9/11
09-14605 35x75x9/11
09-14613 25x55x9
09-14616 35x75x8/10
09-14617 35x55x7

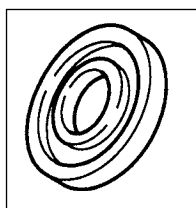

Polaris

09-140 30x62x8
09-14102 30x44x7
09-14103 30x62x8/11
09-14104 30x44x5,7
09-14202 30x62/63,7x7
09-14619 40x64x8

Kohler

09-104 25x42x10/11
09-113 30x42x7

Yamaha

09-131 25x48x8
09-132 30x72x8
09-135 32x78x10x13
09-137 32x78x9,5
09-143 32x48x10
09-14301 35x80x6
09-14302 25/32x78x8
09-14303 25/32x48x8
09-14306 23/35x58x12
09-14311 32x48x9,2
09-14313 32x48x10

Ski-doo

09-113 30x42x7
09-11301 32x42x7
09-116 25x62x10
09-118 25x41,55x10
09-122 35x62x10
09-125 25x52x7/7,5
09-16002 25x62x63,5x5x6
09-16003 30x62x63,5x5x6
09-165 35x72x7/8
09-167 30x62x7/8
09-168 28x38x7
09-169 30x47x7
09-170 40x80x7

Sachs

09-108 30x47x8
09-114 25x35x7,9

Transmissiondrev 13 spår dia 24 mm

11 links wide

45-016	16 h
45-017	17 h
45-018	18 h
45-019	19 h
45-020	20 h
45-021	21 h
45-022	22 h
45-023	23 h
45-024	24 h

13 links wide

46-016	16 h
46-017	17 h
46-018	18 h
46-019	19 h
46-020	20 h
46-021	21 h
46-022	22 h
46-023	23 h
46-024	24 h

15 links wide

49-016	16 h
49-017	17 h
49-018	18 h

Transmissiondrev 15 spår dia 26 mm

11 links wide

47-016	16 h
47-017	17 h
47-018	18 h
47-019	19 h
47-020	20 h
47-021	21 h
7-022	22 h
47-023	23 h
47-024	24 h

13 links wide

48-016	16 h
48-017	17 h
48-018	18 h
48-019	19 h
48-020	20 h
48-021	21 h
48-022	22 h
48-023	23 h
48-024	24 h

15 links wide

50-016	16 h
50-017	17 h
50-018	18 h
50-019	19 h
50-020	20 h
50-021	21 h
50-022	22 h

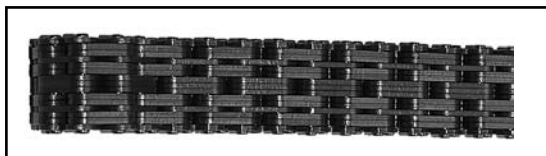

Silent keja

11 links wide

45-064	64 l
45-066	66 l
45-068	68 l
45-070	70 l
45-072	72 l
46-074	74 l

13 links

46-064	64 l
46-066	66 l
46-068	68 l
46-070	70 l
46-072	72 l
46-074	74 l

15 links

50-064	64 l
50-066	66 l
50-068	68 l
50-070	70 l
50-072	72 l
50-074	74 l

Yamaha

Bromsbelägg



05-15224 par



05-15228 st



05-15245 st



05-15249 par

Arctic Cat

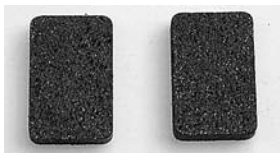

05-15225 par
AC 0109-932

Bromsklossar



05-15232 par
AC 0115-603



05-15240 par
AC 0702-264

Polaris



05-15241 par
AC 0702-229

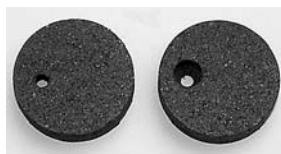

05-15203 par
Pol 193034/5



05-15214 st
Pol 1930 569

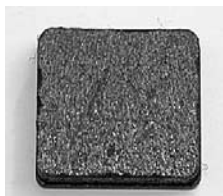

05-15231 st
Pol 1930 588



05-15237 st
Pol 1930 586



05-15243 par
Pol 1930 723

Ski-Doo Lynx



05-15212 par
Sk 860.701.400

Nordik



05-15235 par
Skidoo, Lynx, Nordik



05-15247 par
Sk 860.701.700



05-15241 st
Sk 414.933.700
Lynx

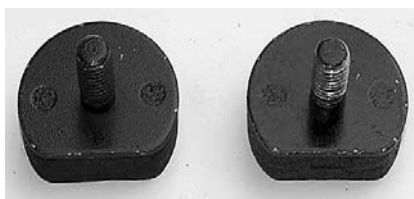

05-15242 par
Sk 860.700.700
Lynx



05-15246 st
Sk 414.990.000
415053600 Lynx

Vindrutor

00-110	5 393 062	GL 250 - >88
00-111	524090X	GL 250 S, GL 230 89->91
00-112	526754	GL 360 S 92->95
00-115		539504 Forest Fox 96->98, 01
00-120	522842X	GL 3900, GLX 5900 metalfäste->93
00-121	538284-1	GLX 5900, skruvhål 1995
00-122	523192X	GLS 3300 låg
00-123	538616	GLX 5900, laxfena 1995
00-130	524126X	GL 3300, GL 3900 S, 88->92
00-131	526976	COBRA 1992
00-132	527091	COBRA 1992->93
00-133	538837	COBRA 94->95, ULTRA 94->96
00-140	5393890-1	640
00-141	6500202-2	650 skruvhål 1995
00-142	533084X	650 met. 83->94
00-151	537644	RANGER, LIGHT, GT 93->97
00-161	5241171	RANGER; LIGHT hög
00-171	5241478	G-TYPE, svart 1997-00
00-172	5143618	G-TYPE, G-TOUR, Sport XR , låg
00-173	5143619	G-TYPE, XR 500 F, G-TOUR: högre
00-181	5241686	GLX 5900 96->99, 6900 1997
00-300	Nordik 300	
00-377	Nordik 377 R	
00-500	Nordik 500, 600, 7 fenor	
00-510	Trapper, 5000, 5 fenor	
00-550	Nordik 550	

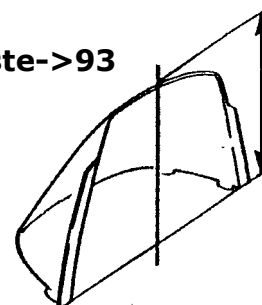

Vindrutor är originala

Obs: mät alltid rutans höjd längs rutans ytan i mitten !!!

Förgasargummi



07-10010 570.038.900 377,447,503

07-10023 570.038.100 582,583,670,536,643



07-10011 377 vinkel

07-10020 253 / 90 grader

Tätningar

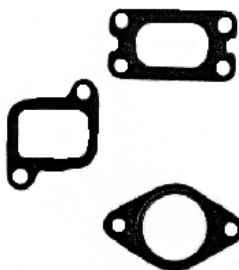

08-101 Rotax **377-447-503**

avgasrör

08-100 Rotax **377-447-503**

insugningsrör

08-102 Polaris

avgasrör

Rep. sats (MIKUNI)



08-103 Mikuni (07-187-05)

08-104 Mikuni (07-187-11)



03-7000 Primer pump



03-7311 Filter



Backspegel 12-165 par



El i luften, fröken Filippa

CDI-Boxar



01-14342
Rotax 410.918.900



01-14343
Rotax 420.965.591



01-401
Arctic Cat 3004-099



01-14340
Rotax 420.866.595



01-415
Yamaha 8V0.85540.21



01-407
Polaris 3083725



01-14345
Rotax 420.965.757



01-40701
Polaris 3083989



01-40801
Polaris 308400



01-14329
Arctic Cat 3003-777

Tändspolar



01-14310
Rotax 410.916.000



01-14311
Rotax 410.913.500 Arctic



01-14312
Arctic Cat 3003-221



01-14313
Polaris 3082974



01-143120
Arctic Cat 3003977

CDI-Boxar

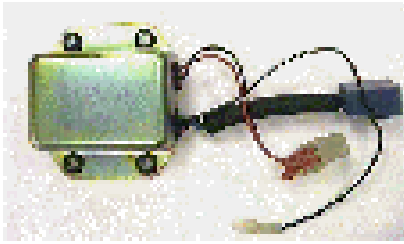

01-14372
512.058.927 Skidoo

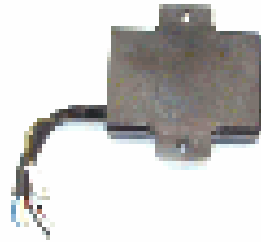

01-406
3083721 Polaris 600-650

Tändspolar



01-14314
Yamaha 8W3.82310.10



01-14315
Yamaha 8E7.82310.10



01-14317
Yamaha 335.82310.40



01-14351
Yamaha 8AB.82310.10



01-14353
Arctic Cat 3003-575



01-14355
Rotax 410.920.500



01-14360
Polaris 3084469



01-14361
Arctic Cat 3004-126



01-14362
Arctic Cat 3004-483



01-1430
Rotax, Bosch, Arctic Cat



01-14367
Polaris 3085293



01-14370
415.085.400 Formula

Voltregulatorer

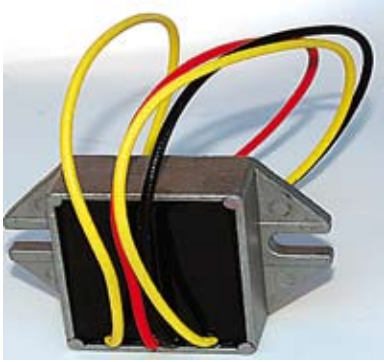

01-15416
01-15416B

3 tråd likriktare
4 tråd likriktare



01-15402
Rotax 410.908.900



01-15406
Rotax, Arctic Cat



01-15417 **250 W**
Rotax



01-15415
Rotax 410.908.900



01-15421 Likriktare
Polaris 4060122



01-15418
Likriktare Arctic Cat



01-15426
Arctic Cat 0232-014



01-15432
Yamaha 82F.81910.



01-15435
Yamaha 82M.81910.AO



01-15436
Yamaha 98A.81910.00

Styrstål**järn****coromant****AKTIV**

Alaska	1986
Panther	1984-86
Karibo	1984-

ARCTIC CAT

El Tigre	1980-84
Jag	1980-91
Pantera	1980-85
Panther	1980-89
Super Jag	1987-92
Trail Cat	1980-81

Cheetah Tour	1987-91
Coucar	1987-91
El Tigre	1987-90
Jag AFS	1989-91
Manx	1991
Pantera	1987-90
Panther	1990-91
Wild Cat 650	1988-90

Ext Special	1992
Ext 580,Z	1993-94
Jag Special,Z	1992
Prowler Spec.	1992-94
Wild Cat 700 EFI	1992-94
ZR 440	1993-95
ZR 580,700	1993-95
Thunder Cat	1996

Bear Cat 340,440	1995-99
Cheetah Tour	1992-94
Cougar	1992-97
Ext, EFI	1992-93
Jag AFS DL	1992-93
Manx	1992-93
Pantera	1992-97
Panther	1992-93
Prowler	1991-96
Prowler 2-UP	1992-94
Puma	1991-97
Thunder Cat	1993-95
Wild Cat EFI	1992

El Tigre	1985-86
Cougar	1985-86
Cheetah	1986
Pantera	1986

Plastskida	1996-
------------	-------

MM203

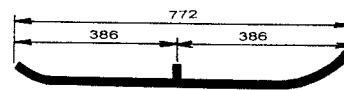

MM169

MM203

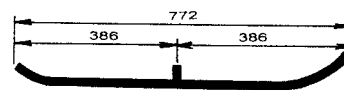

MM169

MM205



MM170

MM260



MM133

MM210

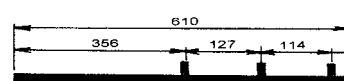

MM173

MM261

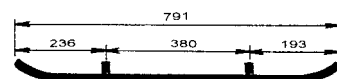

MM262

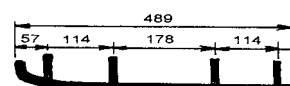

MM157

Styrstål

järn

coromant

LYNX

Forest Fox	1999-
GL360, 250	1991-93
GL 2300	1990
GL 3300	1989-90
GL 3900, LTS	1991-92
GLS 3900	1989-90

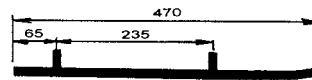

MM242

MM189

GLX 5900, LTS	1991-93
GL Sport, LTS	1991-92
Ranger	1993

GL 250, 2505	1986-89
GL 3900	1983-88
GL 5900	1983-90
535, 650	1983-87
640	1988

MM230

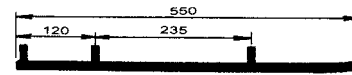

MM187

GLS 3300	1986-89
GLS 3500 F/C	1990-93
GLS 3600 L/C, 3800 Rave	1990-91
Cobra	1992-93
Cobra Touring, Rave	1993
Cobra Racing, Enduro Ultra	1993

MM240

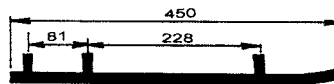

MM188

230, 250, 650	1989-93
---------------	---------

MM241

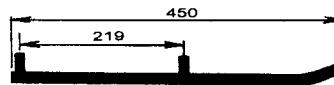

G-type Rave Enduro 600	1997-99
---------------------------	---------

MM265

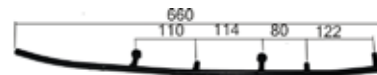

MM154

G-type Racing Sport XR 98	1998-
------------------------------	-------

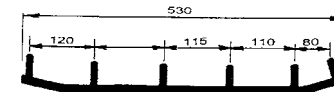

MM153

G-type Enduro 500	1997-99
----------------------	---------

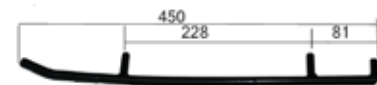

MM152

Ranger kort stålskida	2000-
--------------------------	-------

MM250

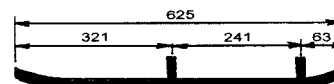

MM193

FLEX plastskida	2000-
-----------------	-------

MM279

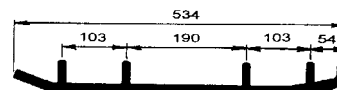

MM146

Plast skida Skidoo	2003-
--------------------	-------

MM277

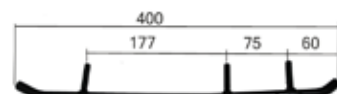

MM147

ADJ skida CTRL skida	2003- 2004
-------------------------	---------------

MM243

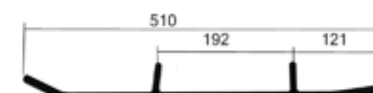





MM186

Styrstål

järn

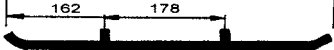
coromant

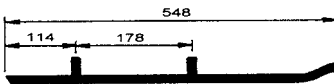
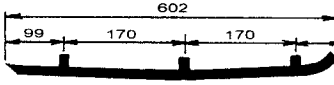
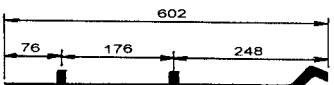
SKI DOO

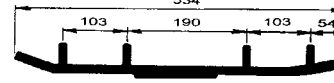
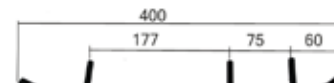
Citation	1980-91	MM211		MM174
Elan	1971			
Safari Cheyenne	1989-91	MM215		MM176
Alpine II	1991-95			
Blizzard	1978-84			
Everest	1974-83	MM275		MM145
Nordik	1981-83			
Olympique	1976-79			
Skandic 277, 377	1982-85			
TNT	1973-78			
Formula Mach I	1989-94	MM216		MM163
Formula MX, XTC	1985-95			
Formula Plus, XTC	1985-93			
Formula SS	1995-96			
Formula ST, STX	1994-96			
Grand Touring 470	1995			
Safari DL, 503 Rally	1993-94			
Safari GLX, LCE, L	1990-94			
Skandic II 377, 503	1992-94			
Formula SP DL	1985-86	MM229		
Safari 377, 447, 503	1984-88			
Safari, Saga, Scout	1989-92			
Skandic 377, 503	1986-87			
Tundra	1985-97			
Formula III	1985-96			
Formula Mach Z	1985-96			
Formula MXZ	1993-95			
Formula Z	1994-96			
G-Touring 583, 670	1993-96			
Summit	1994-96			
Formula 500, DL	1996-99	MM250		MM193
Formula 583	1996-99			
Formula S, SL, SLS	1995-99			
G-Touring 500	1996			
Scandic 380, 500	1995-			
MXZ 440, 583, 670	1996-99			
Formula 583	1998			
Formula III 600, 700	1997-99			
Formula Mach I, Z	1997-99			
Formula Z	1997-99			
G-Touring 583, 670	1997-99			
Summit	1997-99			
Plastskida FLEX	1997-	MM279		MM146
Plast skida	2003-			
Blow molded		MM277		MM147
Skandic 380-550	2003-			

Styrstål

järn

coromant

POLARIS

Alla modeller	1971-82	MM208
Indy 400	1984-85	
Indy 600	1983-85	
Indy Trail	1983-85	
Longtrac	1983-85	
Indy Sport	1983	
SS	1983-85	
Star, LT	1983-85	



Indy 400	1986-87	MM 209
Indy 600	1986-87	
Indy Trail	1986-87	
Indy Longtrack	1986-87	
Indy Sprint	1986-87	
SS	1986	
Star, Startrack	1986-87	



MM177

Indy Sport	1987	MM206
Alla modeller	1988-98	
Stålskida	1998-99	

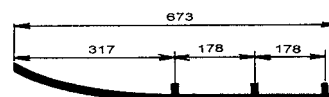

MM159

Plast skidor		
Indy RMK 700	1997-	MM270
Indy XC 440	1997-	
Indy XCR 600	1997-	
Indy Storm	1997-	
Indy Ultra	1997-	

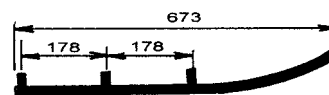

MM149

OCKELBO

Alla modeller	-1986	MM207
---------------	-------	-------

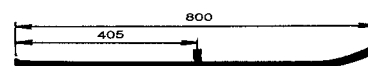

MM160

Alla modeller	1987-	MM228
---------------	-------	-------

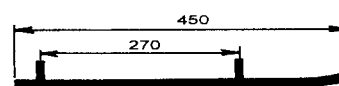

MM162

NORDIK

Nordik 300-377		MM215
Nordik 500-600		
Nordik 540-600 SL		

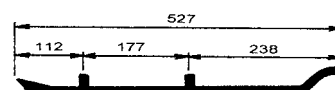

MM176

SLP

SLP skida		MM290
-----------	--	-------



MM190

Pilot skida, Skidoo		MM274
---------------------	--	-------



MM144

Styrstål

järn

coromant

YAMAHA

BR 250	1982-94
ET 250, 300, 340	1977-84
SR 540	1980-84
SRX 440	1976-80

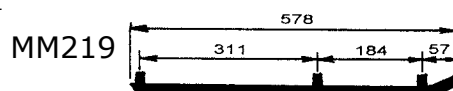

ET 340	1985-88
--------	---------



Exiter 570	1987-90
SR 540, V-MAX 540	1987-91

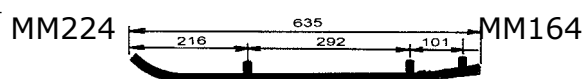

BR 250 T, TS	1984-98
ET 340 T, TR	1981-88
ET 400 T, TR	1989-91
EX 340, 440	1977-81

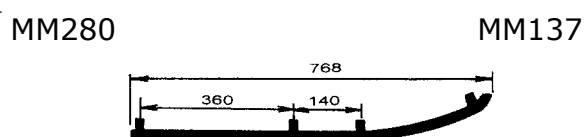

CS 340	1990-99
Exiter II 570, SX	1991-93
Phazer II, E, ST	1984-99
SR 540	1985-86
V-Max 540	1983-86
Viking II 540	1988-92
XLV 540	1985-91

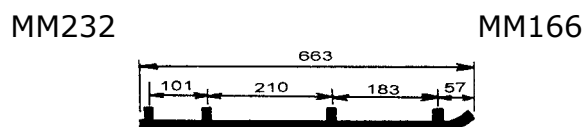

ET 410 TR	1992-99
Viking II 540 E	1993-99
Venture 480	1991-99

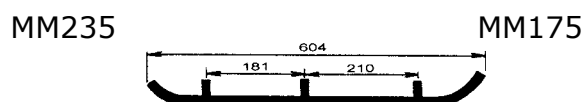

V-Max-4	1992-94
Venture 500,600,700	1995-96
V-Max 500, 600, 700	1994-96
V-Max 800	1995-97

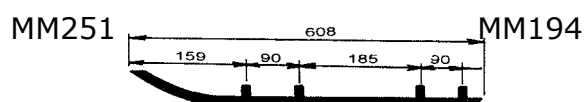

V-max 500, 600, 700	1997-99
Venture 500,600,700	1997-99

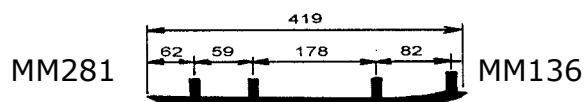

SRX 600, 700	1998-
--------------	-------

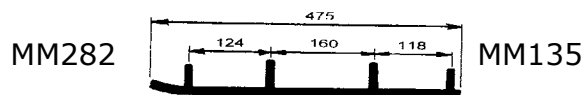

RX, RX-1	2002-
----------	-------



Svensk text: Andreas Buvarp

www.teolehtimaki.fi

